

High current technology · Flexible connectors · Solderless cable connection technology · Electroplating equipment

# druseidtt

Elektrotechnik

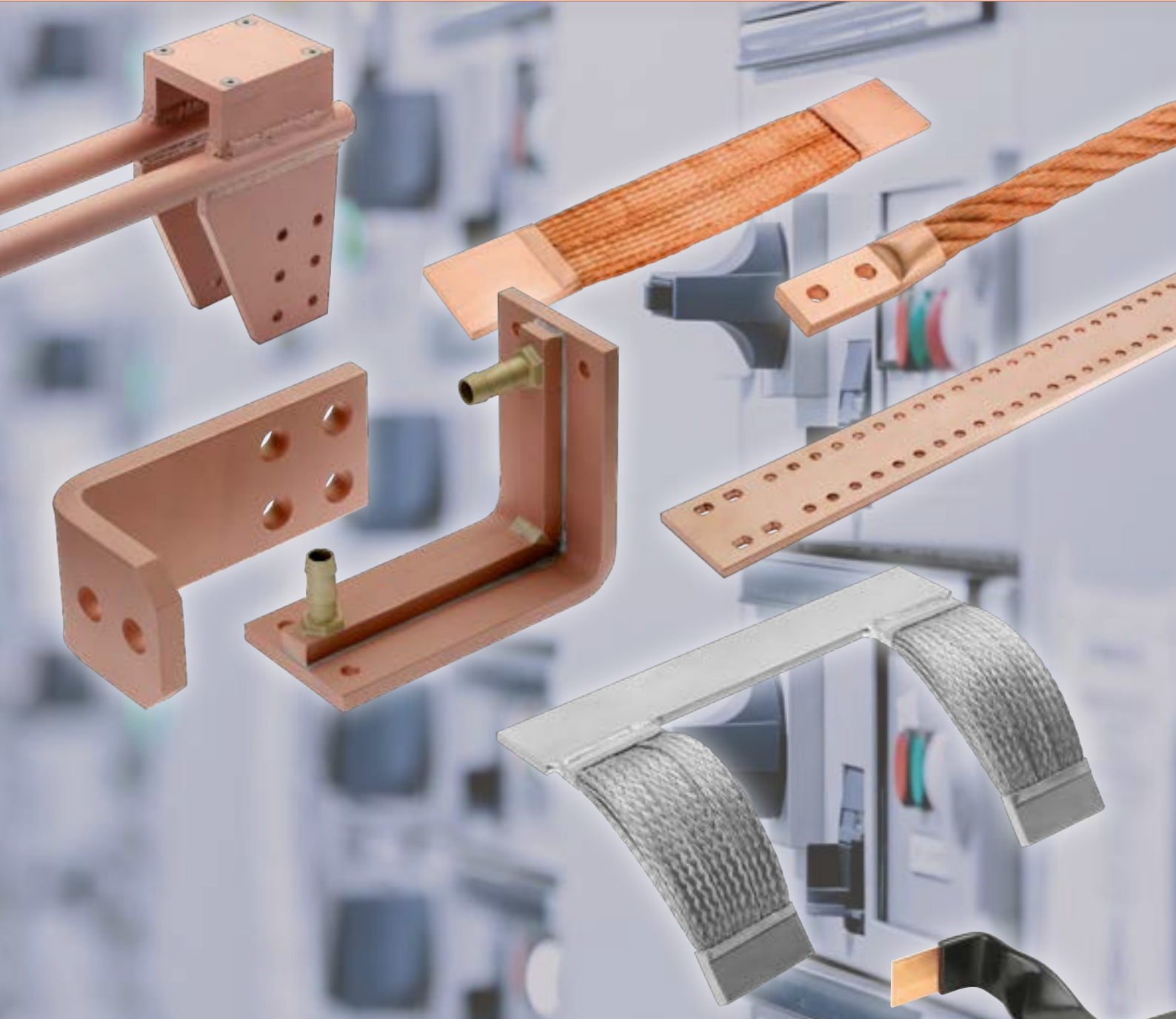

Catalogue No. 4

**Busbars, non-ferrous metal working and accessories**

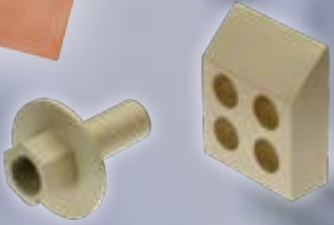

Edition: 10/2023  
busbars, non-ferrous metal working and accessories

Paul Druseidt  
Elektrotechnische Spezialfabrik GmbH & Co. KG  
Neuenkamper Straße 105  
42855 Remscheid, Germany

Phone: +49 (21 91) 93 52-0  
Fax: +49 (21 91) 93 52-150  
http: [www.druseidt.de](http://www.druseidt.de)  
E-Mail: [info@druseidt.de](mailto:info@druseidt.de)

The dimensions and technical data listed in this catalogue have been determined with the greatest possible care and the illustrations correspond to the status at the time of printing. However, we reserve the right to make technical changes as well as changes in dimensions, shape and colour.

**Our specifications, in particular the values for possible current loads, are non-binding guide values. The assignment of conductor cross-sections, of current carrying capacities by national or international standards or regulations is neither restricted nor cancelled by this. Only the details and commitments in our order confirmations are binding for us.**

The use of photos, drawings, catalogue pages etc. for own advertising campaigns or other uses requires or formerly written acceptance.

Decades of experience in the field of high-current transmission, electrical installation technology and power distribution enable us to offer a comprehensive range of services from design/engineering to complete components or ready-to-install busbar systems. All from one source. Competent and reliable.

## OUR EXTENSIVE RANGE OF SERVICES

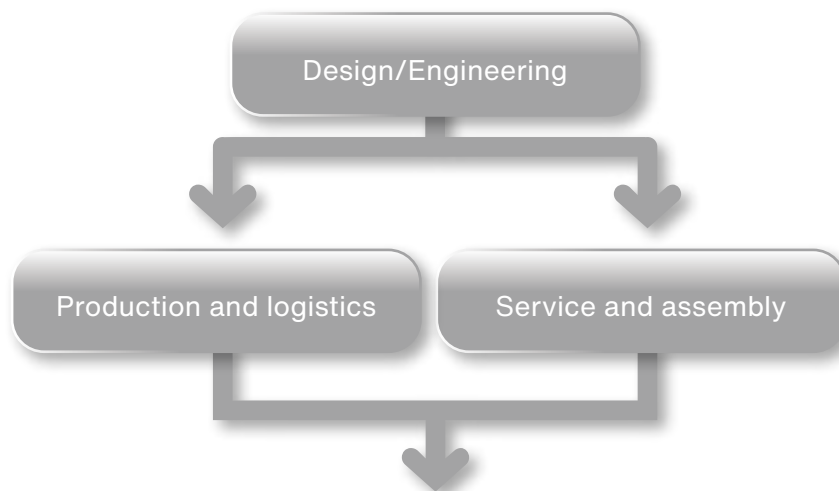

## OUR PRODUCTS

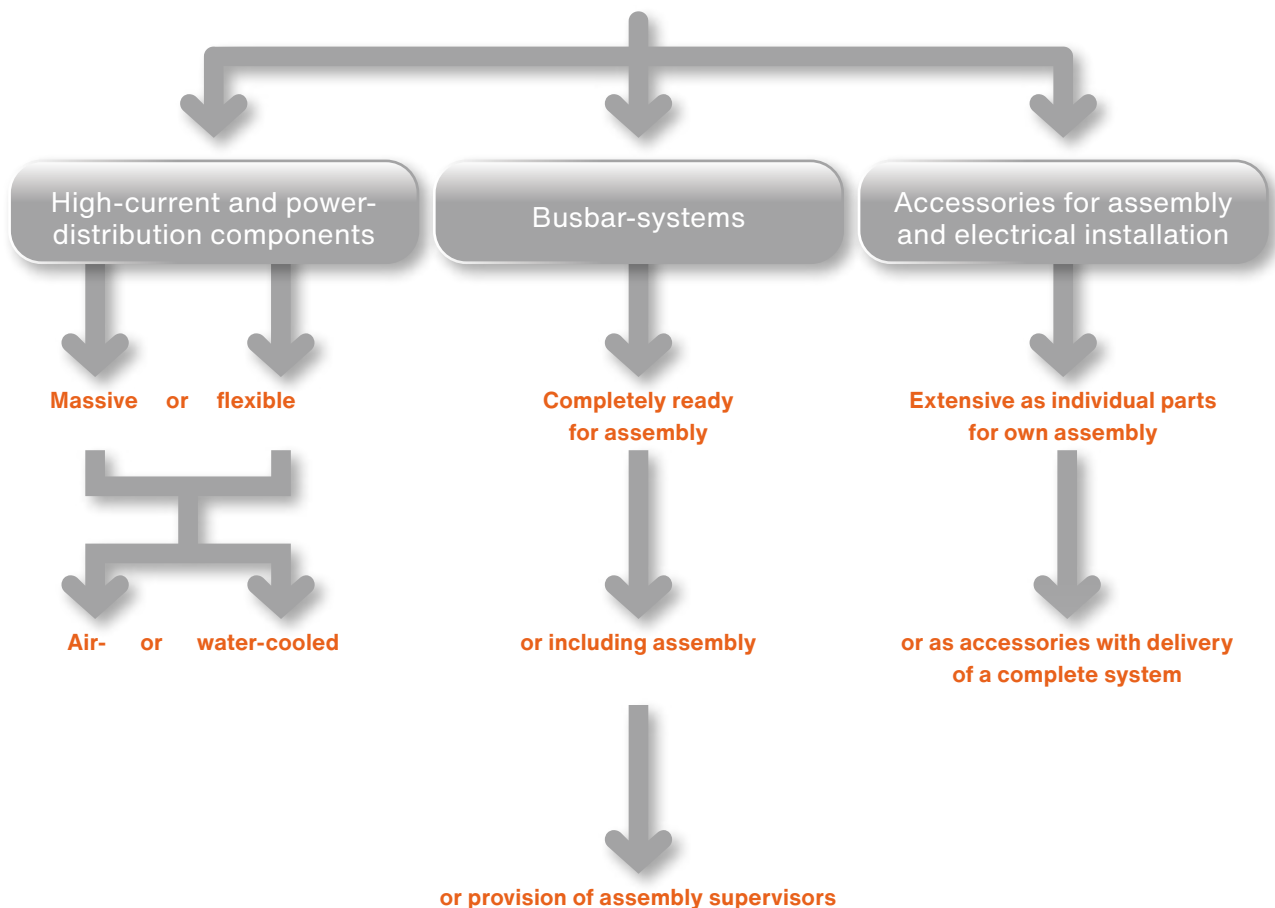



## High Quality and reproducible production processes

Our field of activity is high-current transmission. Therefore currents of several thousands amperes are no problem for us.

We pay attention to first-class quality and have corresponding reproducible manufacturing processes at our disposal.

We are certified according to ISO 9001 2015 and ISO 14001 2015 and maintain a comprehensive quality- and environmental management system.

We design with 3D-CAD-systems and implement our designs in production by using CAM technology.

We are flexible and offer extensive manufacturing options for individual solutions.

We offer comprehensive electrotechnical advice for the construction of new or modernization of older systems.

We design and supply complete busbar systems or individual special solutions according to your wishes.

We guarantee compliance with a high quality standard and fast availability of almost all standard products.



Design reliability through the use of modern CAD/CAM technology

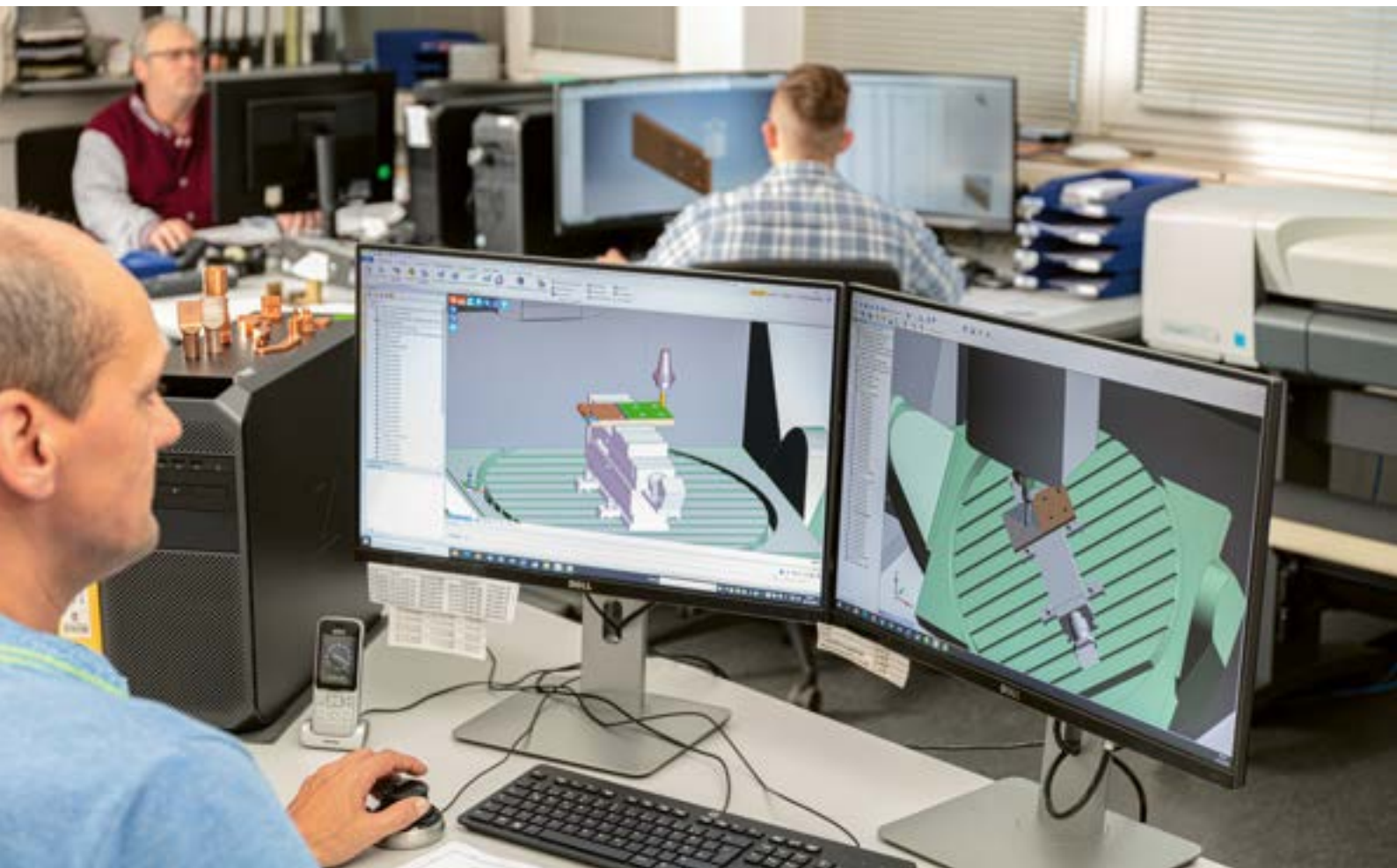

## Careful inspection and control

We have comprehensive testing capabilities. In this way, we create the foundations for our high quality standard.



conductivity test



material testing



dimensions check



hardness test

## Table of contents

Article	Catalogue Page
Range of services for machining solid parts	8-9
Busbar systems	10
Manufacture of complex curved busbars	11
Stamped and punched copper- and aluminium-bars	12
Bent and punched copper- and aluminium-bars	13
Punched or edged sheet metal parts out of copper and bimetallic materials	14
Bimetallic sheets and washers	15
Welded and soldered copper- and aluminium components	16
Milled and turned components made of non-ferrous metals	17
Perforated and unperforated busbars according to customer requirements	18/19
Earth and potential equalization bars	20/21
Busbar supports	22/23
Busbar holders	24-27
Standoff insulators	28-30
Flexible high-current connectors	31-33
Highly flexible high-current connectors made out of flat braid	34/35
Highly flexible high-current connectors made out of round stranded copper cables	36/37
Flexible expansion connectors made out of copper and aluminium strips	38/39
Insulated supple bars	40-42
Screw material	43/44
Technical appendix/tables short circuit values/support distances	45/46



## High current and power distribution components as well as accessories for assembly and electrical installation

We manufacture and deliver high current components and accessories for various kinds of branches and application.

- Busbars and busbar components
- Earth and neutral busbars
- Stamped and punched copper- and aluminium parts according to your samples and drawings
- Punched and bent sheets
- Bimetallic sheets and washers
- Welded copper- and aluminium-components
- Turned and milled parts according to sample or drawing
- Standoff insulators
- Busbar supports and busbar holders
- Flexible connectors consisting out of copper braid and round stranded copper cables
- Expansion connectors consisting out of copper and aluminium foils
- Insulated supple bars
- Connection terminals for supple bars
- Screw material

## Our range of services in the field of solid part machining

We are specialized in the manufacturing of busbars and power distribution components made out of copper, aluminium or brass. In addition to precise reproducible and cost-effective production of individual parts or small series, our modern machinery also enables extremely efficient serial production or the manufacture of complex components.

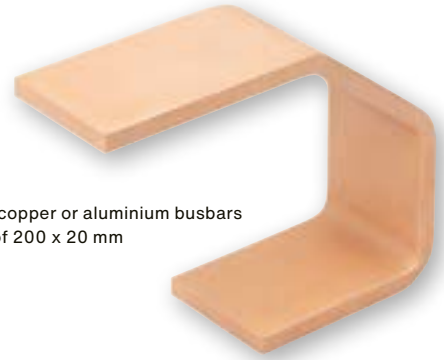

Bent and punched copper or aluminium busbars up to a dimension of 200 x 20 mm

Automated punched copper or aluminium busbars up to a dimension of 200 x 15 mm

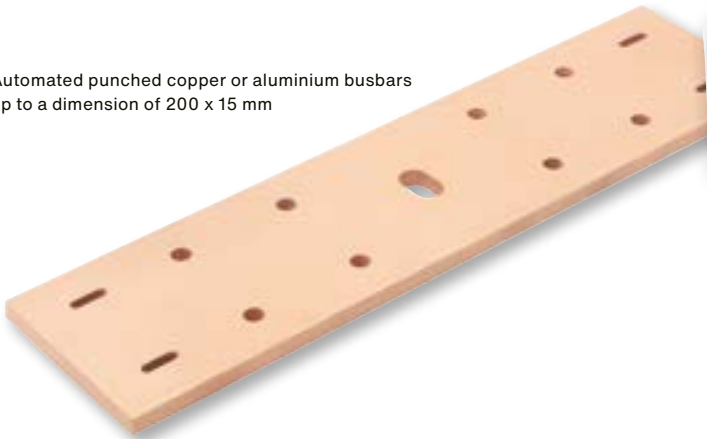

Busbars or profiles out of copper bent over the high edge



Torsion bent copper bars up to a width of 100 mm and a thickness of 10 mm



3D bent busbars up to a width of 100 mm and a thickness of 10 mm



Edged large busbars or angles in a width of > 200 mm up to ca. 1000 mm and in strengths up to ca. 35 mm



Many years of experience in the design and development of individual solutions for the high-current sector offer our customers the best possibilities for the efficient and cost-effective production of components and assemblies. In addition to the stamped and bent parts, we offer turned and milled parts or welded or soldered components too.

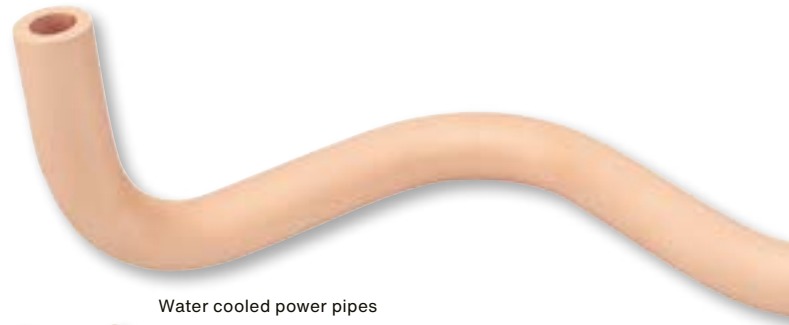

Water cooled power pipes

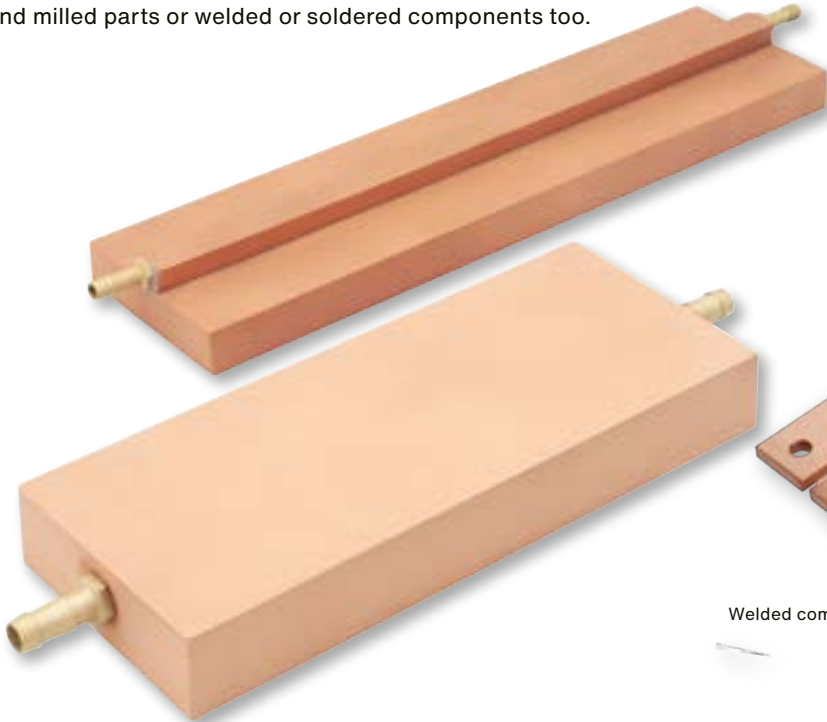

Water cooled busbars in different designs

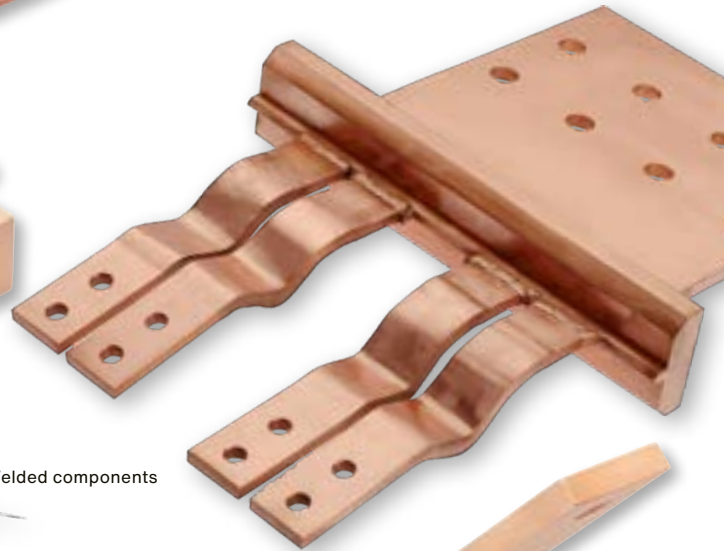

Welded components



Turned parts



Soldered components



Milled parts

## Busbar systems

We design and manufacture busbar systems made of copper and aluminium bars individually adapted to the respective application. Whether for new constructions, conversions or extensions of older plants, we supply complete systems including busbar supports, flexible connections and even the complete screw- and installation material. Even currents of several thousands amperes with correspondingly large busbar cross-sections are no problem for us. The design is carried out on CAD-systems and the subsequent production on modern machines with varying degrees of automation.

If the corresponding 3D-data is available, 90-95 % of the busbar system can be prefabricated in our company and delivered directly to the construction site with all the necessary installation accessories. This considerably shortens necessary assembly times on site, which can reduce costs, especially since the production of components in the factory is much cheaper than machining them on site. On request, we can also provide personal to supervise the installation or carry out installation work with our own personal.

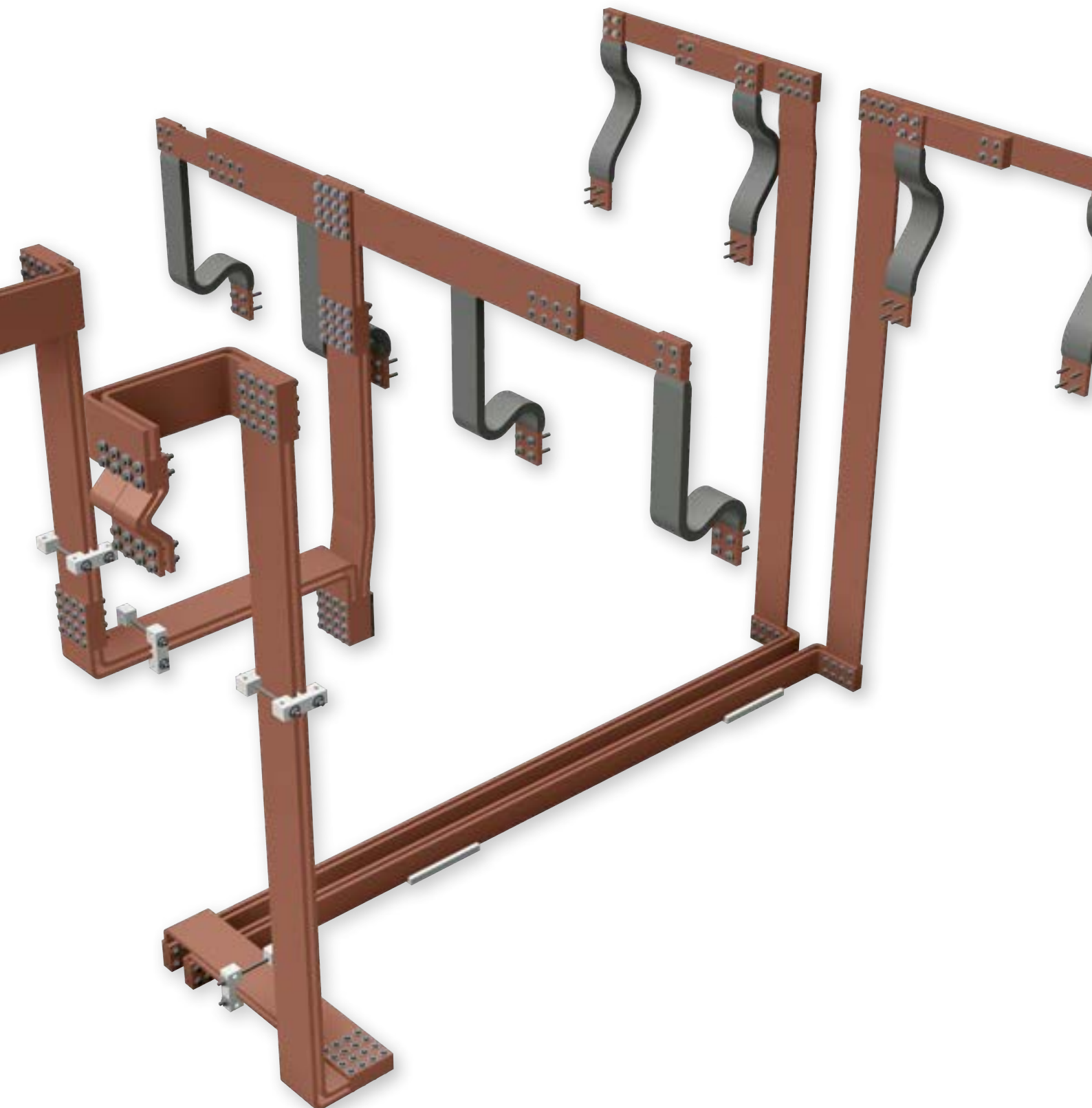

## Manufacture of complex curved busbars

We have equipment and bending techniques, which enable the production of copper bars with complicated bending shapes, e.g. torsion bending, bending over the high edge, production of 3D-busbars or bending of copper bars with large cross-sections > 200 mm bar width up to approx. 1000 mm and approx. 35 mm thickness.

### Torsion bending

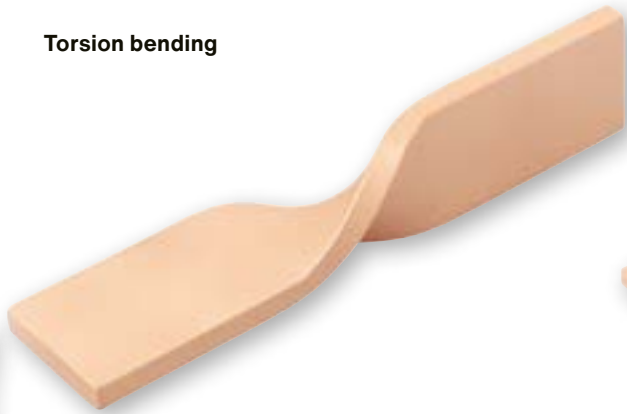

By means of torsion bending, the connection level can be changed without any problems even when working with solid busbars

### Bending over the high edge



Bending of copper bars of different widths and thicknesses over the high edge

### 3D-busbars

3-dimensional bent busbars are produced by a combination of torsion- and bending over the high edge. They reduce the number of screw connections and thus the electrical contact resistances, the assembly time and the amount of material required (Savings in copper weight compared to a comparable screwed design). Consequently, fewer bolting points in the systems also need to be maintained.

For torsion bending or the production of 3D-busbars, standard tools are available for bar widths of 50/60/80 and 100 mm and 10 mm thickness. Production tools for other bar widths or thicknesses up to approx. 120 mm wide are available on request. Various bar dimensions and cross-sections are also available for bending over the high edge. Further information about dimensions, bending radii and technical possibilities are available on request.

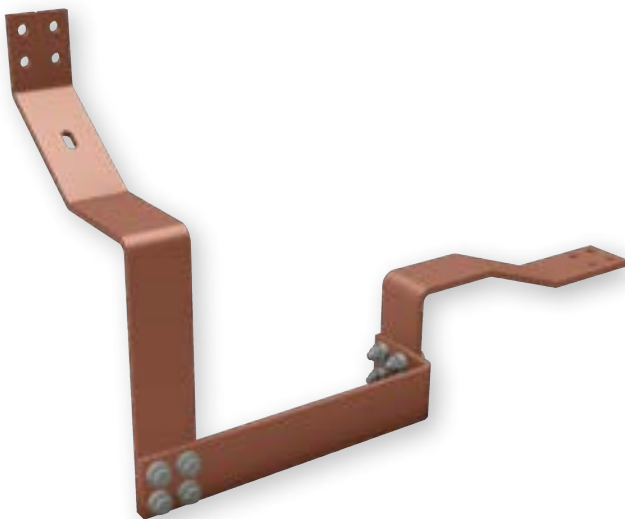

3 busbars screwed together

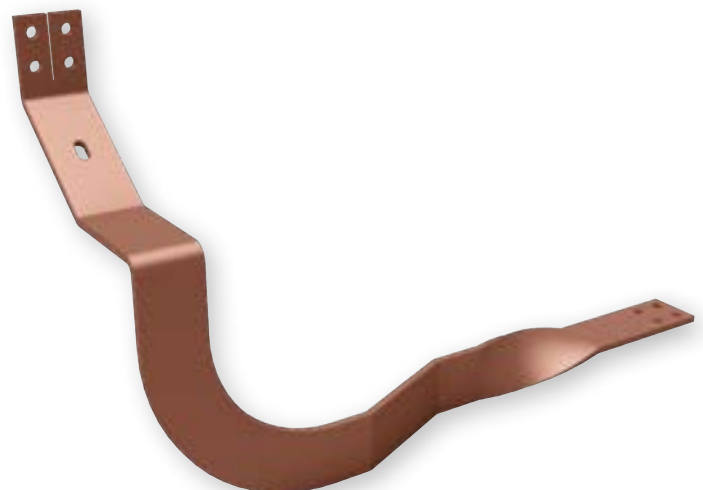

All bent from one piece



## Stamped and punched copper- and aluminium bars

We supply stamped and punched busbars made of bar material in almost all technically possible shapes and designs.

From widths of 15 mm and thickness of 3 mm up to widths of 200 mm and thicknesses of 15 mm, cost effective automated production options are available for small and medium quantities as well as large series. We are also happy to support you in the construction and design of suitable components. On this catalogue page, you can see some examples that can serve as inspiration for your design or inquiry.

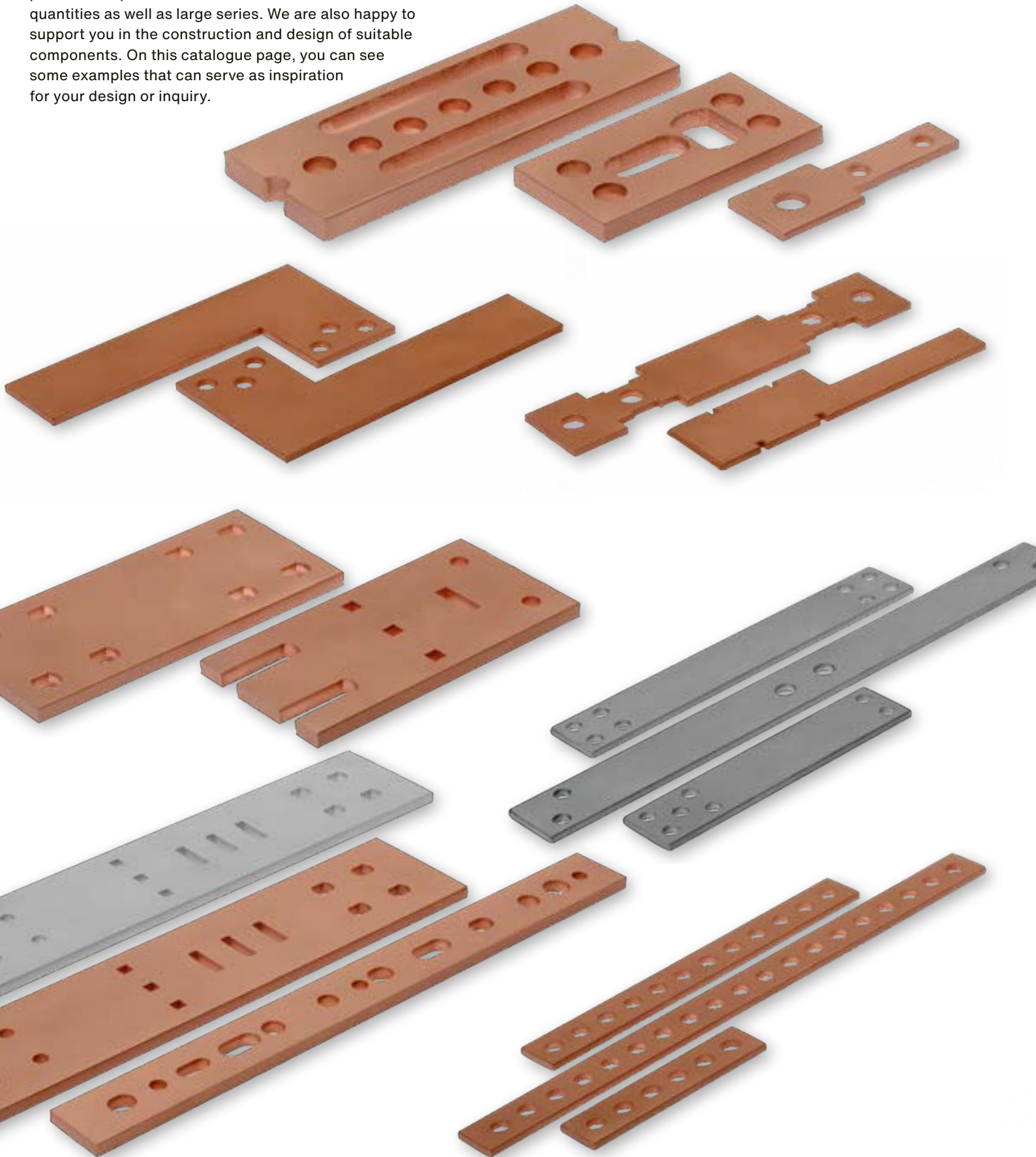

## Bent and punched copper- and aluminium busbars

In addition to our range of stamped parts, we are also equipped for the cost-effective production of bent and punched busbar components. We manufacture copper- and aluminium busbar components up to cross-sections of 200 x 20 mm on various machines or, alternatively, on large high-performance machines, busbar cross-sections up to approx. 1000 x 35 mm in small as well in large series.

The design is carried out exactly according to your wishes or drawings. Designs with water cooling are possible too. On request, we can also support you in the design of power supply systems and high current components. In this way, the design and manufacture of power supply systems and components can be carried out from a single source in a cooperative partnership.

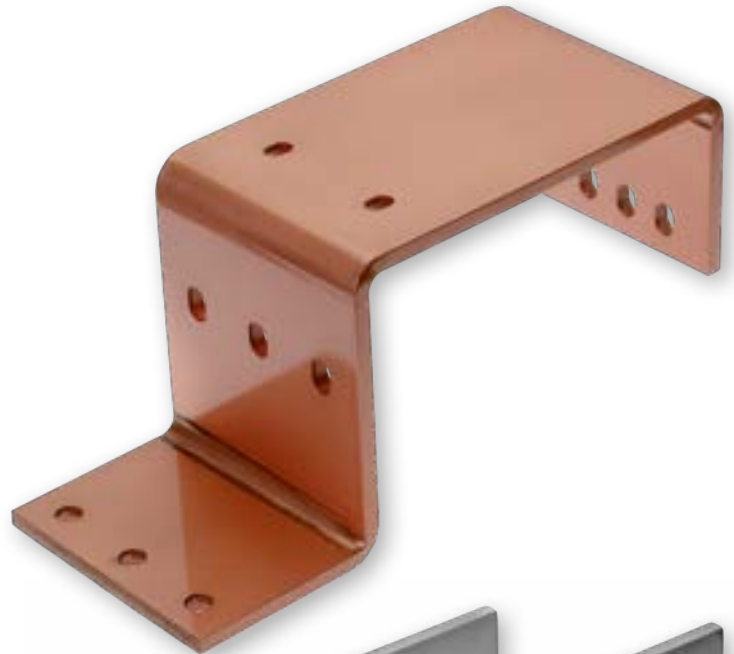
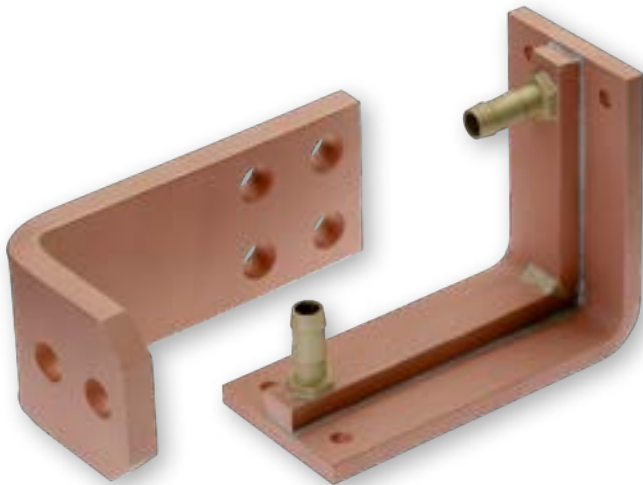

## Surface plating / Insulations

On customer request, we also supply components with surface finishes such as tin-plated, nickel-plated, silver-plated etc. as well as insulation such as shrinkable tubing or others.

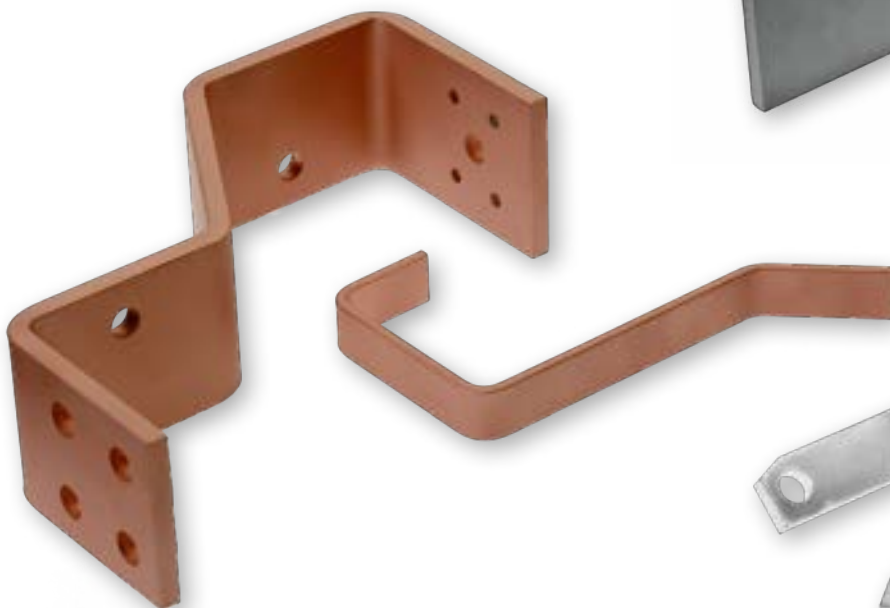

## Punched or edged sheet metal parts made of copper and bimetallic materials

According to your individual wishes or drawings, we manufacture smaller finished sheet metal parts made of copper up to 5 mm or bimetallic sheets up to 2 mm thickness. Designs with surface finishing or soldered contact parts are also available on request. Here you can see some samples:

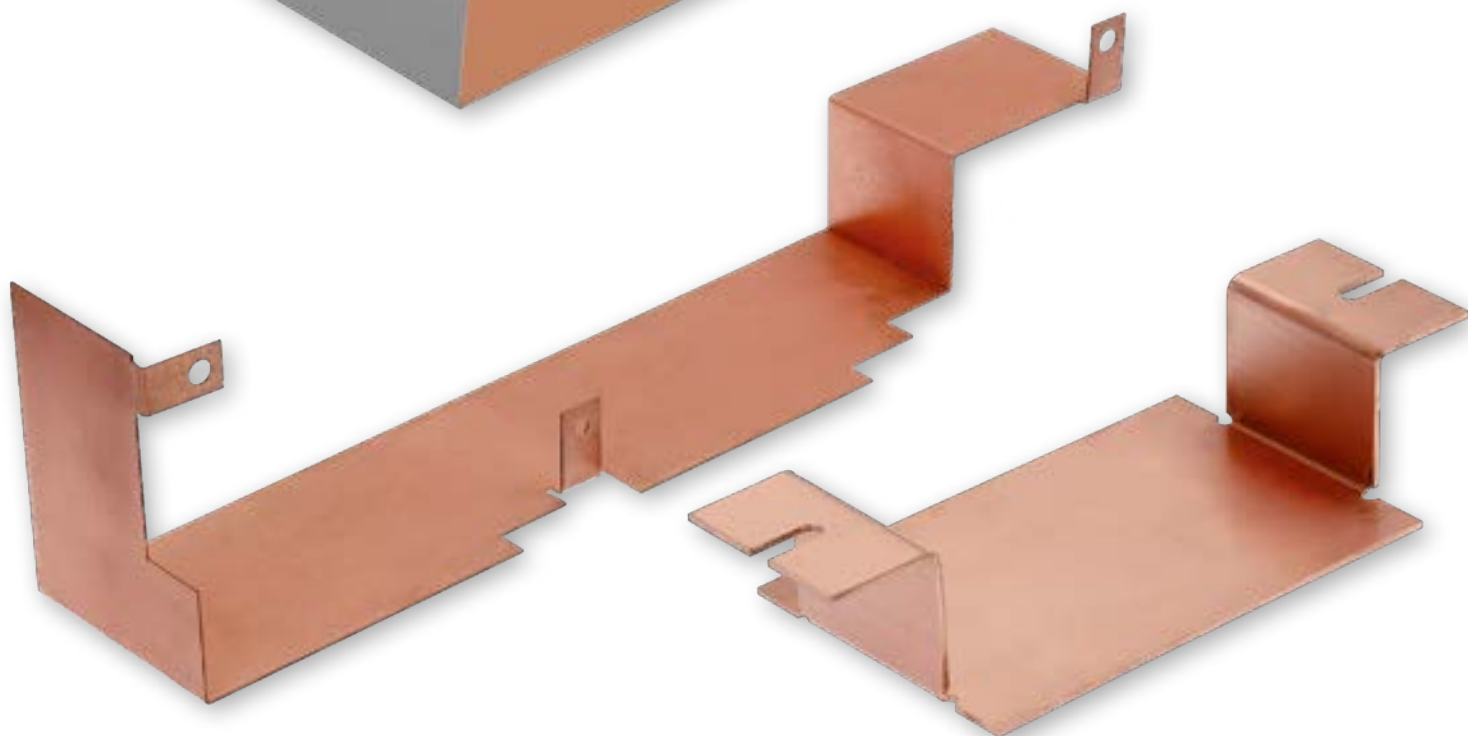
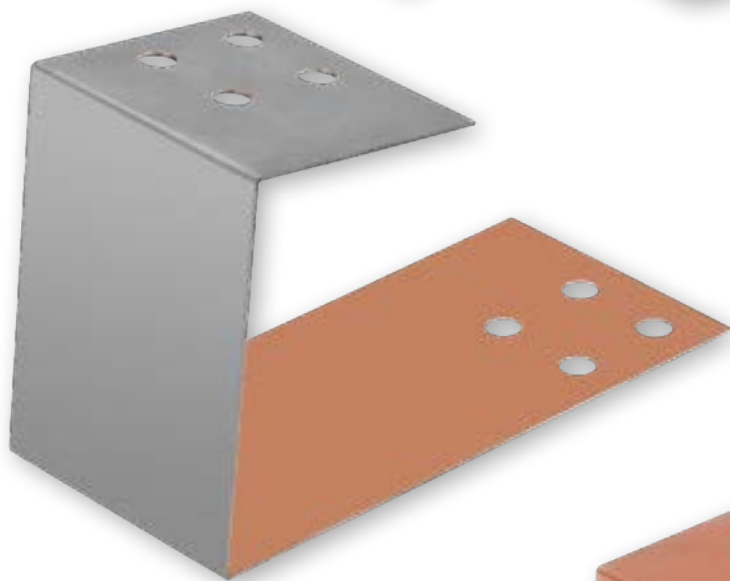



## Things to know about joining copper to aluminium-components

Bare, uncoated copper bars often have to be connected to uncoated aluminium bars or components. According to the electrochemical voltage series however, various conductively connected metals that are jointly wetted by liquids, such as water or acids, form an electrolytic element that leads to corrosion.

The greater the voltage differences, the greater the destruction. Aluminium in eight place and copper in twenty-third place in the electrochemical voltage series are subject to a strong risk of corrosion due to the relatively large voltage difference.

**The wide range of druseidt-products includes the supply of complete Bimetallic-sheets, -cut offs and -washers, which can be used as a shim when joining copper and aluminium components.**

### Bimetallic sheets

Bimetallic sheets consist of copper clad aluminium sheets in a 70/30 ratio (70 % aluminium and 30 % copper). Since the joint between the two metals is located inside the sheets, air and moisture cannot enter. With this material, as an intermediate layer, a contact-safe and corrosion-protected connection of copper and aluminium is possible. In addition to the Bimetallic sheets and washers, we also supply cut offs with and without holes suitable for your applications.

Part-No.	Technical data				weight kg/pcs.
	dimensions mm				
	length	width	thickness		
02670	2000	500	1,0		4,70
02671			1,5		7,00
02672			2,0		9,35



### Bimetallic washers

Part-No.	Technical data					weight kg/% pcs.
	dimensions mm					
	for thread M	outside- Ø	hole- Ø	S		
13295	3	8	3,5	1,0		0,02
13296	4	10	4,5	1,0		0,03
13297	5	12	5,5	1,0		0,05
02675	6	15	6,5	1,0		0,07
02676	8	18	8,5	1,0		0,09
02677	10	22	10,5	1,5		0,18
02678	12	25	13,0	2,0		0,68
02679	12	28	13,0	2,0		0,44
02680	16	35	17,0	2,0		0,86

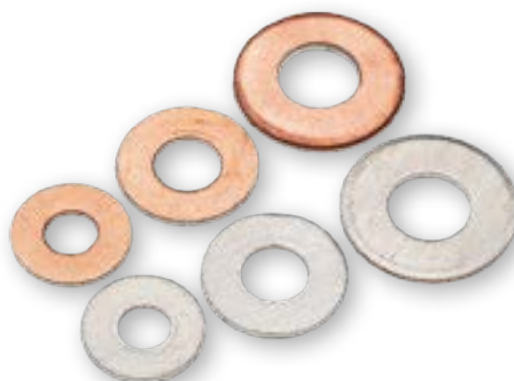

## Welded and soldered copper and aluminium components

We are specialized in the production of welded or soldered high-current components made out of copper and aluminium materials. This production area is supported by our design department and our various machining departments who are specialized in non-ferrous metal processing too.

In close dialogue with our customers, we can develop suitable components and solutions for high-current transfer. For example, in combination with our production of flexible connections it is also possible to manufacture welded or soldered components with movable connection part or expansion compensation.

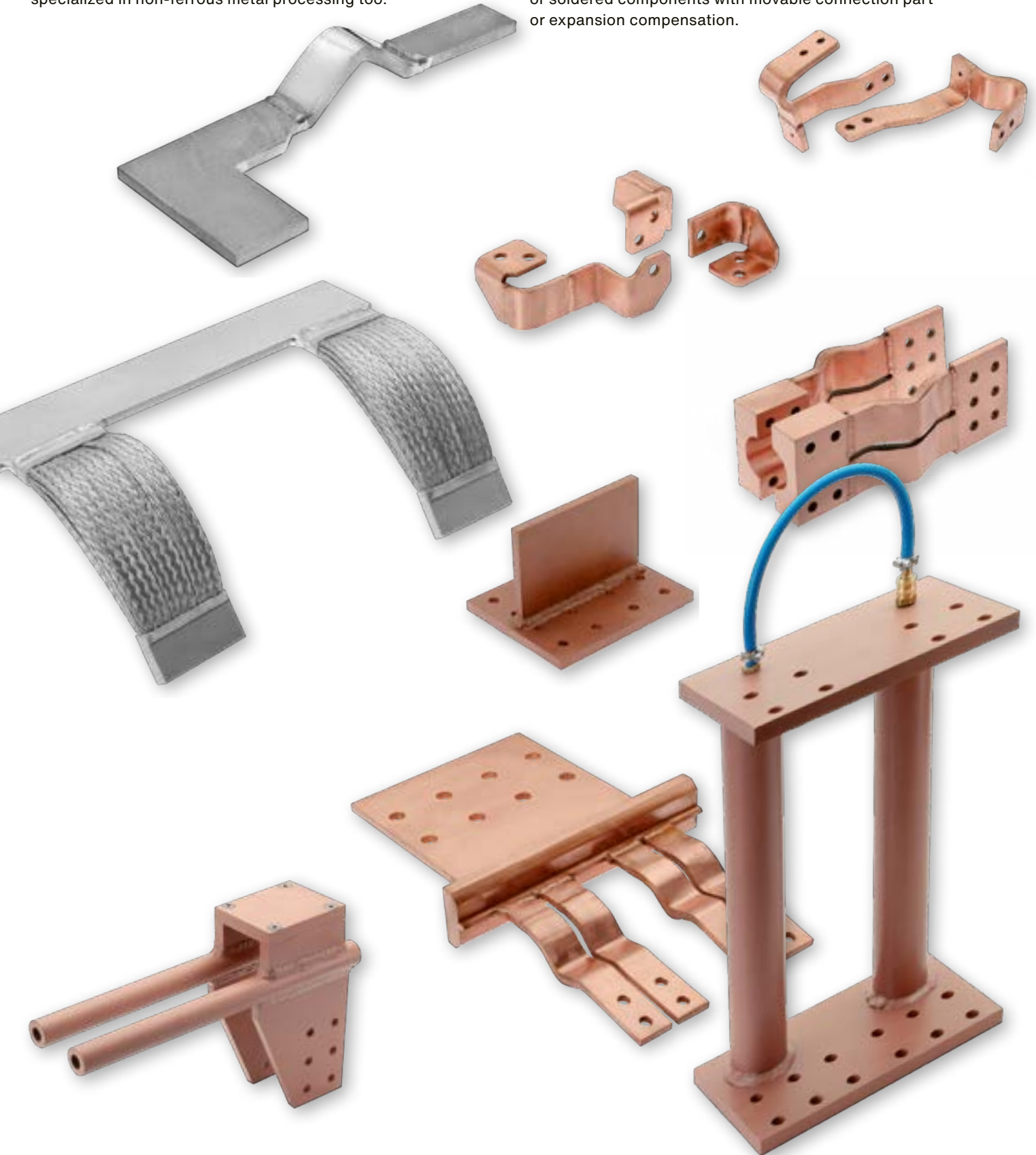

## Milled and turned components made of non-ferrous metals

We design and manufacture high-current components made out of non-ferrous metals. We produce a wide variety of components cost-effectively on modern turning, milling and drilling machines. Depending on the complexity and quantity of the work pieces, production takes place on three- or five-axis machines with varying degrees of automation.

We attach great importance to a maximum of quality and reproducibility of the processes. The manufacturing processes are supported by modern CAD/CAM-technology. We can realize both the manufacturing of individual parts and deliver at short notice.

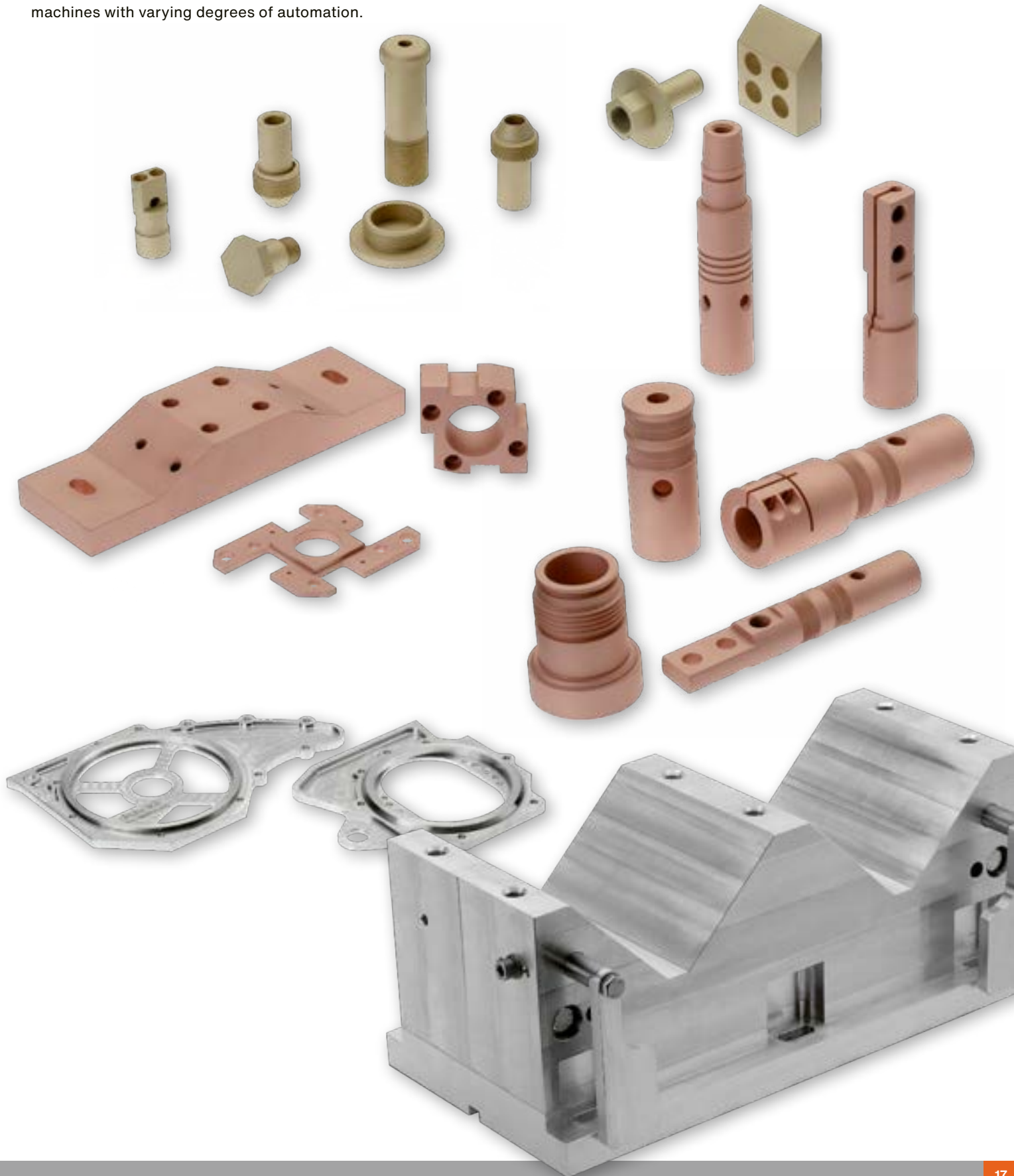



## Perforated and unperforated busbars according to customers specifications

We supply and manufacture busbars made of copper, aluminium or aluminium alloys in both, unperforated or perforated design. Perforated busbars allow vertical connection between busbars of the same and different cross-sections as well as insulated supple bars, flexible connectors, ready made cables etc. without additional drilling. This enables a time-saving professional installation even for already existing systems.

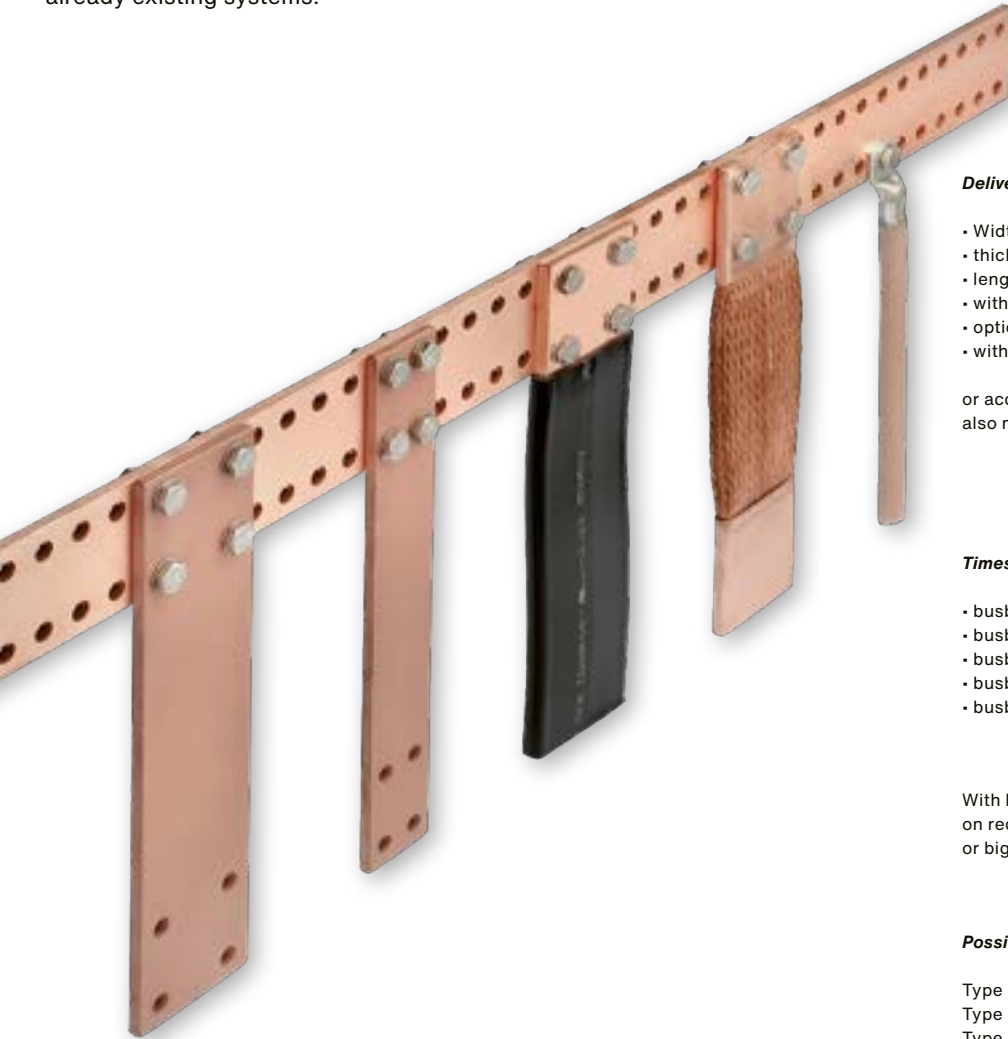
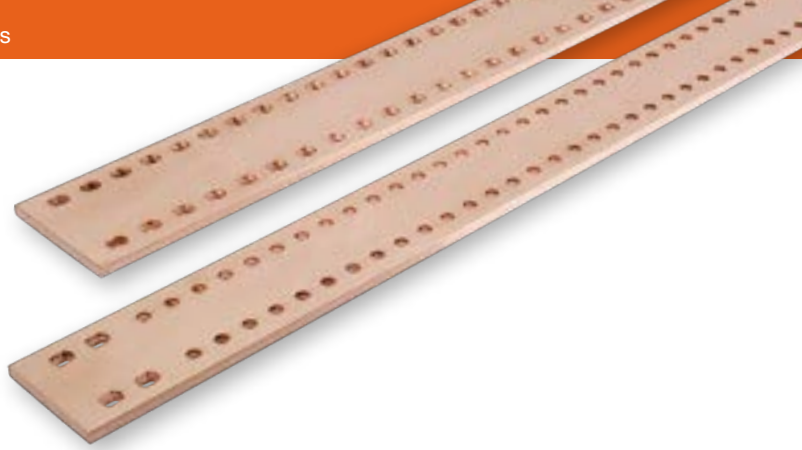

### Deliverable designs:

- Width 15-200 mm
- thickness 3-15 mm
- length up to 4 m
- with round or slot holes
- optional with rounded edges
- with or without threaded holes

or according to your requirements  
also made out of AL 99,5 / AL MgSi 0,5/AL MgSi 1 etc.

### Timesaving installation when connecting:

- busbars which have the same dimensions
- busbars which have different dimensions
- busbars with insulated supple bars
- busbars with flexible connectors
- busbars with readymade cables

With hole pattern according to your wishes or drawings on request. We deliver individual items as well as small or bigger series according to your instructions.

### Possible designs:

- Type I round holes on one side
- Type II round holes on both sides
- Type III 2 slot holes at the beginning and the end of the bar, rest round holes
- Type IV slot holes on both sides
- Type V without holes

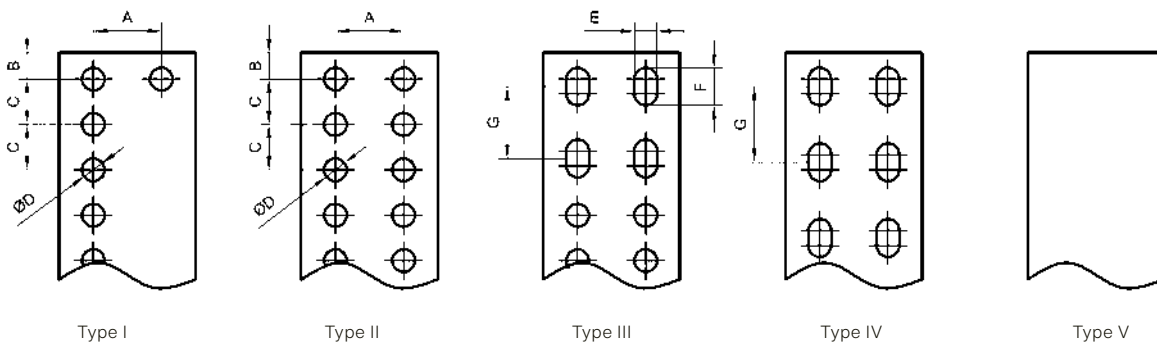

Type I

Type II

Type III

Type IV

Type V

The slot holes are at the beginning and at the end of the busbar. All others are round holes.

### Ordering Information

<b>Material:</b>	<b>Surface:</b>	<b>Dimensions:</b>					
<input type="text"/> E-Copper	<input type="text"/> uncoated	width:	<input type="text"/>	A:	<input type="text"/>	D Ø:	<input type="text"/>
<input type="text"/> AL 99,5	<input type="text"/> tinned	thickness:	<input type="text"/>	B:	<input type="text"/>	E :	<input type="text"/>
<input type="text"/> other materials	<input type="text"/> other coatings	length:	<input type="text"/>	C:	<input type="text"/>	F :	<input type="text"/>
						G :	<input type="text"/>
<b>Type:</b> <input type="text"/>	<b>Pieces:</b> <input type="text"/>						

### Table for the current load of copper- and aluminium busbars acc. to DIN 43671 and 43670

Continuous currents for busbars Cu-ETP/E-Cu and aluminium busbars according to the DIN regulations for rectangular bars in interior systems at + 35° C air temperature and + 65° C bar temperature and vertical bar position. Values for a changed ambient temperature and reducing factors for changed applications are contained in the DIN 43671 or 43670 respectively in the correction factor diagram K2. Supported by the correction factor K2 it is possible to correct the current load acc. to the following table to a changed ambient- and bar-temperature. All values for the current load based on the conditions of an unmoved ambient air, uncoated bars, partial oxidized, so that the emission ratio is 0,35 by aluminum, 0,4 by copper resp. 0,9 when working with painted bars. Under changed or other conditions, please take notice to the values of the norms.

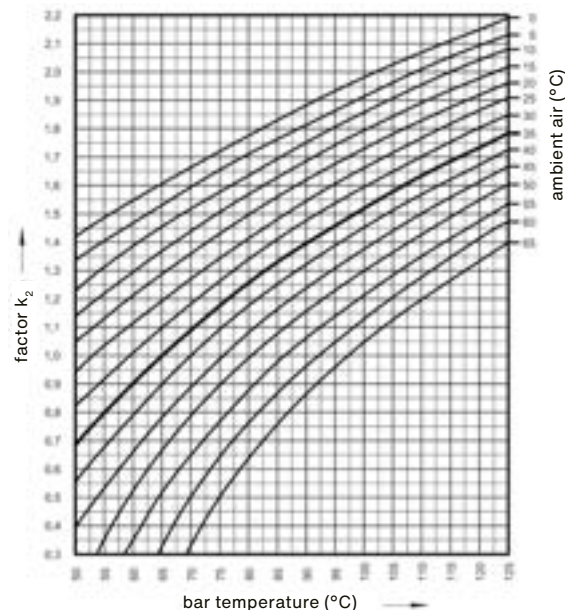

width x thickness mm	weight kg/meter	Material E-copper F30 current load in A				Material E-AL current load in A				
		AC up to 60 Hz bar		DC + AC up to 16 2/3 Hz bar		AC up to 60 Hz bar		DC + AC up to 16 2/3 Hz bar		
		uncoated	painted	uncoated	painted	uncoated	painted	uncoated	painted	
12 x 2	0,210	108	123	108	123	0,060	84	97	84	97
15 x 2	0,270	128	148	128	148	0,080	100	118	100	118
15 x 3	0,400	162	187	162	187	0,120	126	148	126	148
20 x 2	0,360	162	189	162	189	0,110	127	150	127	150
20 x 3	0,530	204	237	204	237	0,160	159	188	159	188
20 x 5	0,890	274	319	274	320	0,270	214	254	214	254
20 x 10	1,780	427	497	428	499	0,540	331	393	331	393
25 x 3	0,670	245	287	245	287	0,200	190	228	191	228
25 x 5	1,115	327	384	327	384	0,340	255	305	255	305
30 x 3	0,800	285	337	286	337	0,240	222	267	222	268
30 x 5	1,340	379	447	380	448	0,410	295	356	296	356
30 x 10	2,670	573	676	579	683	0,810	445	536	447	538
40 x 3	1,070	366	435	367	436	0,320	285	346	285	346
40 x 5	1,780	482	573	484	576	0,540	376	456	376	457
40 x 10	3,560	715	850	728	865	1,080	557	677	561	682
50 x 5	2,230	583	697	588	703	0,680	455	556	456	558
50 x 10	4,450	852	1020	875	1050	1,350	667	815	674	824
60 x 5	2,670	688	826	696	836	0,810	533	655	536	658
60 x 10	5,340	985	1180	1020	1230	1,620	774	951	787	966
80 x 5	3,560	885	1070	902	1090	1,080	688	851	694	858
80 x 10	7,120	1240	1500	1310	1590	2,160	983	1220	1010	1250
100 x 5	4,450	1080	1300	1110	1340	1,350	846	1050	858	1060
100 x 10	8,900	1490	1810	1600	1940	2,700	1190	1480	1240	1540
120 x 10	10,680	1740	2110	1890	2300	3,240	1390	1730	1460	1830
160 x 10	14,240	2220	2700	2470	3010	4,320	1780	2220	1900	2380
200 x 10	17,800	2690	3290	3040	3720	5,400	2160	2710	2350	2960

## Earth and neutral busbars

We manufacture and deliver earth and neutral busbars consisting out of copper or brass with coated as well as uncoated surfaces.

Our standardized delivery program is completed by the manufacturing of designs according to clients wishes or drawings. We deliver busbars up to a length of ca. 4 m with special hole pattern, threads or special coatings.

### Punched E-Copper-bars in customized design

We manufacture punched E-Copper bars with and without screw threads beginning in a width from 15 mm and a thickness of 3 mm with coated or uncoated surfaces. We deliver bars coordinated with your application whether with round or slot holes, or with a hole combination of round and slot holes in different dimensions. Additionally to the delivery of mass produced articles we deliver individual items shortly and to a favourable price.

**Earth and neutral busbars**  
with and without screws  
length: 1000 mm  
material: brass

Part-No.				Technical data			
Type I	Type II	Type III	Type IV	dimensions mm			weight kg/% pcs.
				B x S	connections	distance hole to hole	
02700	02715	02730	02745	10 x 2	62 x M 5	16,0	14,0
02701	02716	02731	02746		90 x M 5	11,0	12,0
02702	02717	02732	02747	12 x 3	83 x M 4	12,0	26,0
02703	02718	02733	02748		64 x M 5	15,5	29,0
02704	02719	02734	02749		58 x M 6	17,0	27,0
02705	02720	02735	02750	15 x 3	105 x M 4	9,5	36,0
02706	02721	02736	02751		86 x M 5	11,5	35,0
02707	02722	02737	02752		50 x M 5	20,0	37,0
02708	02723	02738	02753		50 x M 6	20,0	36,0
02709	02724	02739	02754	15 x 4	42 x M 8	24,0	45,0
02710	02725	02740	02755	25 x 5	31 x M10	34,0	98,0

Type I = busbar brass uncoated, without screws  
 Type II = busbar brass nickel coated, without screws  
 Type III = busbar brass uncoated, with screws  
 Type IV = busbar brass nickel coated, with screws

Steel-screws DIN 84 not mounted are standard.  
 On request it is possible to deliver a mounted design or screws made out of brass.  
 Weight in the table without screws.

**Earth- and neutral busbars**  
with self-locking protection  
rated current 63 A  
material: brass

Part-No.	Technical data					weight kg/% pcs.
	cross-section mm <sup>2</sup>	clamping points	height	width	length	
10535	10	8	9	6,5	51,5	2,5
10536		12			77,5	3,7
10537		18			103,5	5,8
10538		24			155,0	8,1
10539		151			1000,0	43,0
10541	35	Connection terminal for Part-No. 10535-10539				0,3

### Earth and neutral busbars with connection clamps

with self locking protection

rated current 63 A

Material: brass

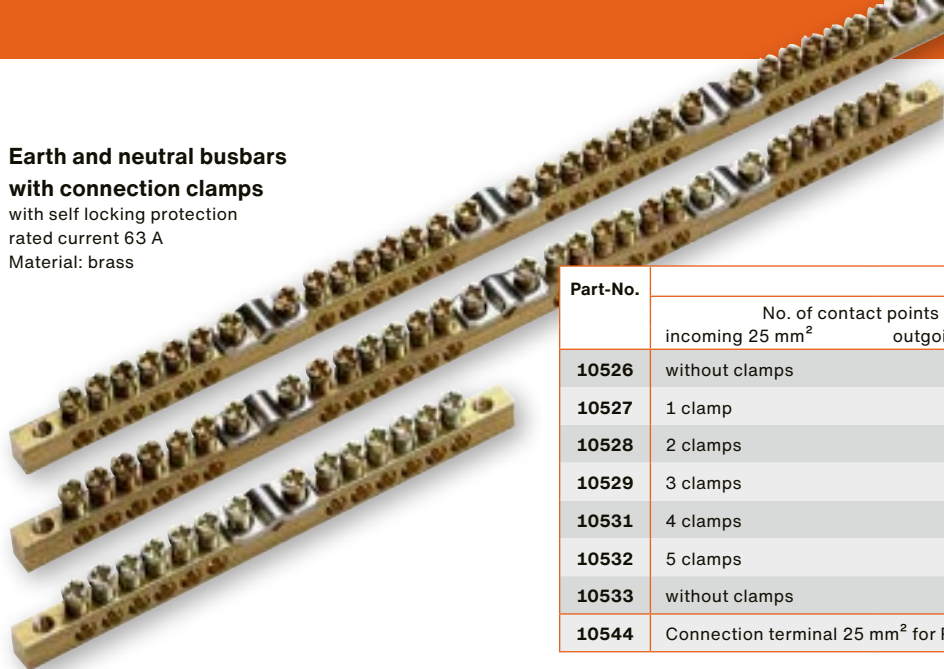

Part-No.	Technical data					
	No. of contact points		dimensions mm			weight kg/% pcs.
	incoming 25 mm <sup>2</sup>	outgoing 10 mm <sup>2</sup>	height	width	length	
10526	without clamps	6	9	6,5	61,5	2,8
10527	1 clamp	12	9	6,5	124,0	6,1
10528	2 clamps	18	9	6,5	186,5	9,4
10529	3 clamps	24	9	6,5	249,0	12,9
10531	4 clamps	30	9	6,5	311,5	16,4
10532	5 clamps	36	9	6,5	374,0	19,4
10533	without clamps	96	9	6,5	1000,0	48,0
10544	Connection terminal 25 mm <sup>2</sup> for Part-No. 10533					0,3

### Insulated earth and neutral terminals

rated current: 63 A

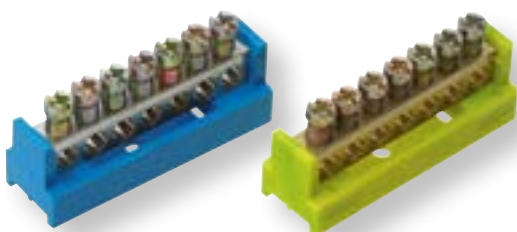

Part-No.	Technical data			weight kg/% pcs.
	cross-section mm <sup>2</sup>	connection points	colour	
<b>For flat bars 12 x 2 mm</b>				
10555	10	7	blue (neutral)	2,8
10556			yellow/green (earth)	
<b>For clip mounting</b>				
10538	10	7	blue (neutral)	2,8
10539			yellow/green (earth)	

### Terminal supports

for earth an neutral busbars



Part-No.	Technical data		weight kg/% pcs.
	description		
02763	Terminal supports with turnable head for busbars 6 x 6 and 10 x 2 up to 15 x 4 mm.	Rated voltage: 500 V AC (VDE 0110 Gr. C).	1,6

### Terminal supports

for earth an neutral busbars 9 x 6,5 mm

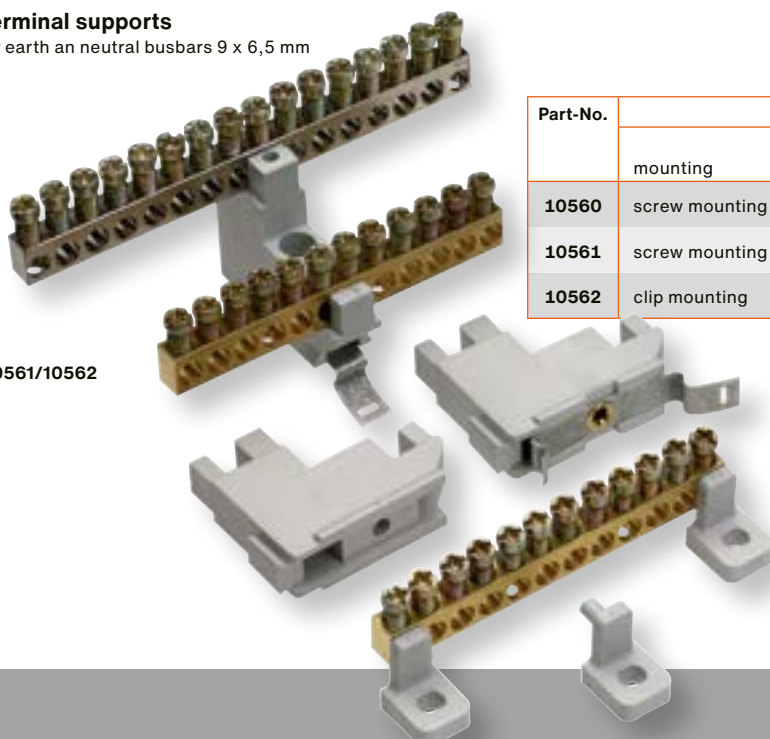

Part-No.	Technical data		weight kg/% pcs.
	mounting		
10560	screw mounting		0,1
10561	screw mounting		0,7
10562	clip mounting		0,8

10561/10562

10560



## Busbar supports

type tested acc. to DIN EN 61439 (VDE 0660-600-1) 2012-06 resp. 61439:2011

operating voltage 1 kV AC, temperature range - 40° C up to + 130° C

Busbar supports made out of glass fibre reinforced unsaturated polyester (UP) similar to DIN 16911 Type 803. Free of halogen, in light grey colour. Three-phase supports, phasing-distance 100 mm (Part-No. 15645) resp. 125 mm (Part-No. 15646).

Two-phase supports with a phasing-distance of 70 mm (Part-No. 15647) suitable for N- and PE-bars The supports offer a vertical clamping of busbars with a thickness of 5 mm or 10 mm resp. 10 mm or 12,7 mm (1/2"). The adjustment of the height can be regulated by the length of the distance bushings.

### Technical data

Deformation resistance	ISO 75	+ 250° C
Behaviour in case of fire	UL 94	Class V-0 at 3,2 mm
Density	ISO 1183	ca. 1,75 g/ccm
Special throughout resistance	IEC 60093	10 <sup>12</sup> Ohm
Dielectric strength (1 mm)	IEC 60243	20 kV/mm
Deeposit tracking	IEC 60112	CTI 600

### Part-No. 15645

#### Busbar supports, phasing-distance 100 mm

For two busbars with a thickness of 10 mm or three busbars with a thickness of 5 mm per phase. The values for the short-circuit-strength and the necessary support distances are listed on page 46.

### Part-No. 15639

#### Distance bushings length 1 m in a paper laminate

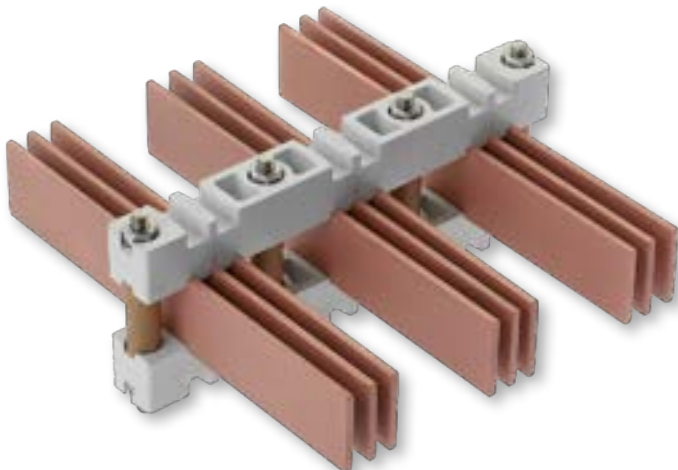
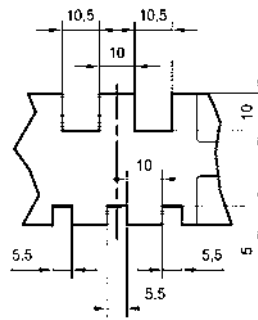
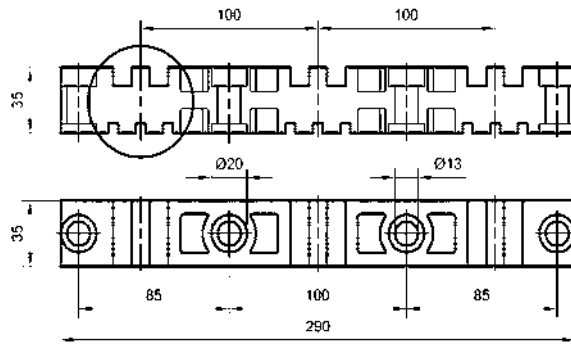
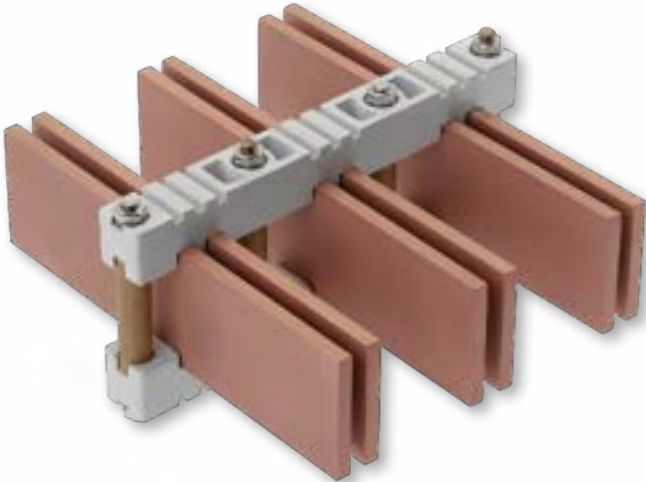

### Current load

AC up to 60 Hz

E-Copper bars dimensions mm	continuously current load by no. of busbars		
	1	2	3
20 x 5	320 A	590 A	810 A
30 x 5	445 A	790 A	1050 A
40 x 5	565 A	980 A	1280 A
50 x 5	685 A	1170 A	1475 A
20 x 10	500 A	965 A	-
30 x 10	670 A	1240 A	-
40 x 10	840 A	1510 A	-
50 x 10	1000 A	1770 A	-
60 x 10	1155 A	2015 A	-
80 x 10	1450 A	2470 A	-
100 x 10	1745 A	2900 A	-
120 x 10	2035 A	3350 A	-
160 x 10	2700 A	4350 A	-

All values in acc. with DIN 43671 by an ambient temperature of + 35° C and a busbar temperature of + 75° C.

## Busbar supports

operating voltage 1 kV AC, temperature range - 40° C up to + 130° C

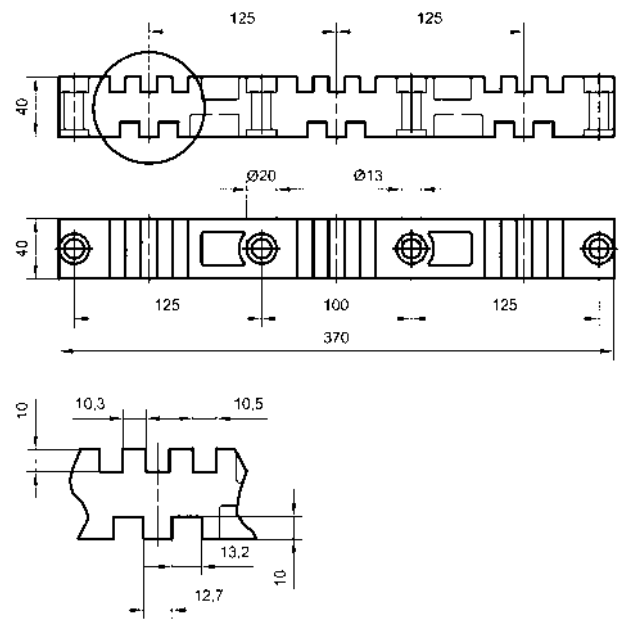

### Part-No. 15646

#### Busbar supports, phasing-distance 125 mm

For three busbars with a thickness of 10 mm or two busbars with a thickness of 12,7 mm (1/2") per phase. The values for the short-circuit-strength and the necessary support distances are listed on page 46.

### Part-No. 15639

#### Distance bushings length 1 m in paper laminate.

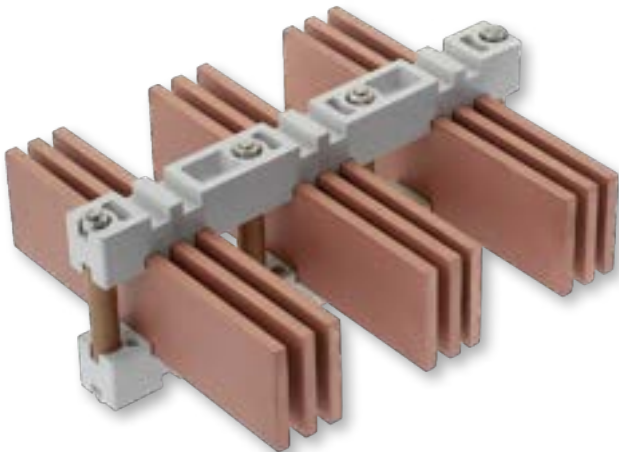

**Current load**  
AC up to 60 Hz

E-Copper bars dimensions mm	continuously current load by no. of busbars		
	1	2	3
40 x 10	840 A	1510 A	2070 A
50 x 10	1000 A	1770 A	2390 A
60 x 10	1155 A	2015 A	2690 A
80 x 10	1450 A	2470 A	3265 A
100 x 10	1745 A	2900 A	3815 A
120 x 10	2035 A	3350 A	4375 A
160 x 10	2700 A	4350 A	5500 A

All values in acc. with DIN 43671 by an ambient temperature of + 35° C and a busbar temperature of + 75° C.

### Part-No. 15647

#### Busbar supports, phasing-distance 70 mm for N + PE bars

Suitable for 2 busbars with a thickness of 10 mm or 3 busbars with a thickness of 5 mm per phase.

### Part-No. 15539

#### Distance bushings length 1 m in paper laminate.

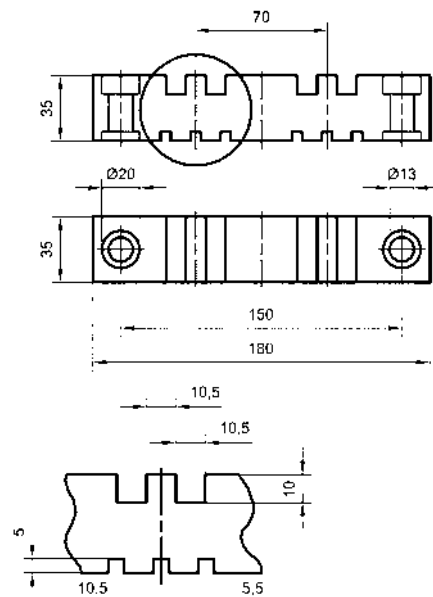
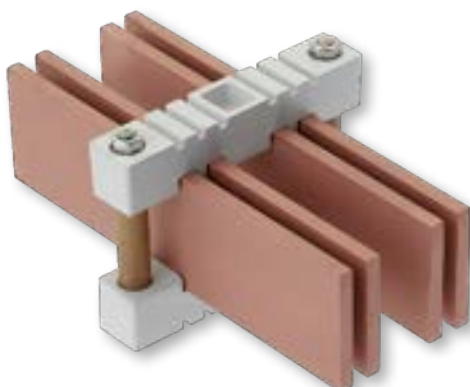

## Busbar holders

**clamping version for vertical busbar guide**

suitable for mounting on insulators

Busbar holders for clamping one or two shorter busbars which should be firmly clamped in the holder in a vertical position.

**Type A:** Suitable for aluminium-bars.

Material of the holder Al MgSi 1,0.

Fastening material stainless-steel

**Type B:** Suitable for copper-bars

or outdoor installations.

Material of the holder Al Mg Si 1,0 with coated surface. Fastening material stainless-steel.

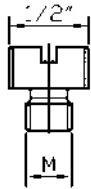
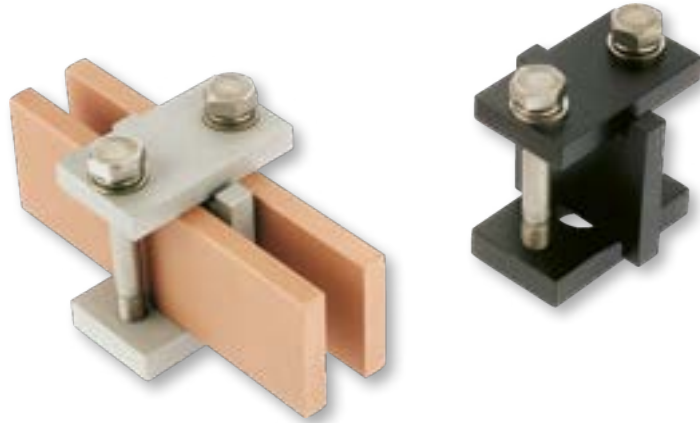

Deliverable threaded reducing-nipples made out of stainless-steel:

Part-No.	
16020	M 8
16021	M 10
16022	M 12
16023	M 16

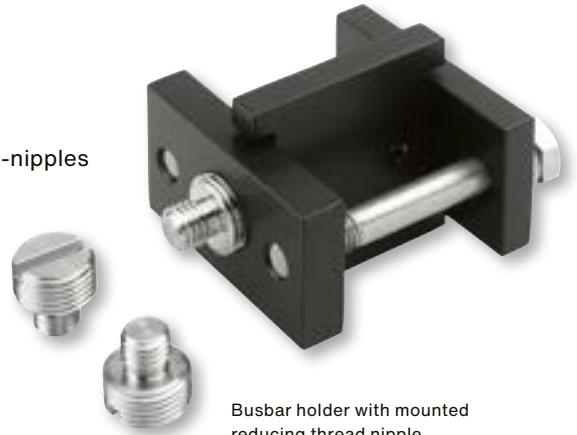

Busbar holder with mounted reducing thread nipple

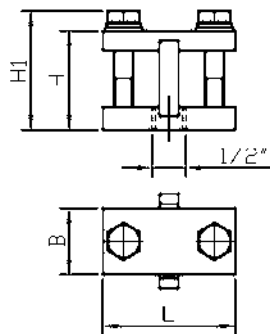
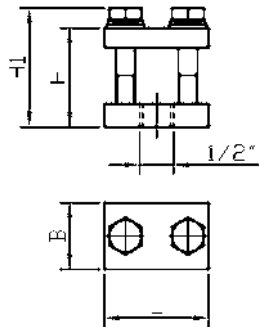

Part-No.		Technical data						
Type A	Type B	number	bar-width	thickness	L	dimensions mm		
						B	H	H <sub>1</sub>
15900	15920	1	30	3 - 20	55	35	52	63
15901	15921	1	40	3 - 20	55	35	62	73
15902	15922	1	50	5 - 20	55	40	72	83
15903	15923	1	60	5 - 20	55	40	82	93
15904	15924	1	80	5 - 20	55	40	107	118
15905	15925	1	100	5 - 20	65	50	127	140
15906	15926	1	120	5 - 20	65	50	147	160

Part-No.		Technical data						
Type A	Type B	number	bar-width	thickness	L	dimensions mm		
						B	H	H <sub>1</sub>
15910	15930	2	30	3 - 10	70	35	52	63
15911	15931	2	40	3 - 10	70	35	62	73
15912	15932	2	50	5 - 10	70	40	72	83
15913	15933	2	60	5 - 10	70	40	82	93
15914	15934	2	80	5 - 10	70	40	107	118
15915	15935	2	100	5 - 10	80	50	127	140
15916	15936	2	120	5 - 10	80	50	147	160

**Note:**

Dimensions in the table for busbar thickness 10 mm. For thinner busbars the dimension L is reduced. The then valid dimensions are available on request when specifying the changed busbar thickness.

## Busbar holders

sliding version for vertical busbar guide

suitable for mounting on insulators

Busbar holders for clamping one or two longer busbars which, because of the heat expansion, must stand in a sliding vertical position in the holder. In this version, the upper clamping piece therefore does not rest on the busbar but on the bolt. Simple and time saving assembly option as the stud bolts can be screwed onto the insulator prior to assembly, making it possible to simply insert the busbar during assembly.

**Type A:** Suitable for aluminium-bars.  
Material of the holder Al MgSi 1,0.  
Fastening material stainless-steel.

**Type B:** Suitable for copper-bars or outdoor installations.  
Material of the holder Al MgSi 1,0 with coated surface.  
Fastening material stainless-steel.

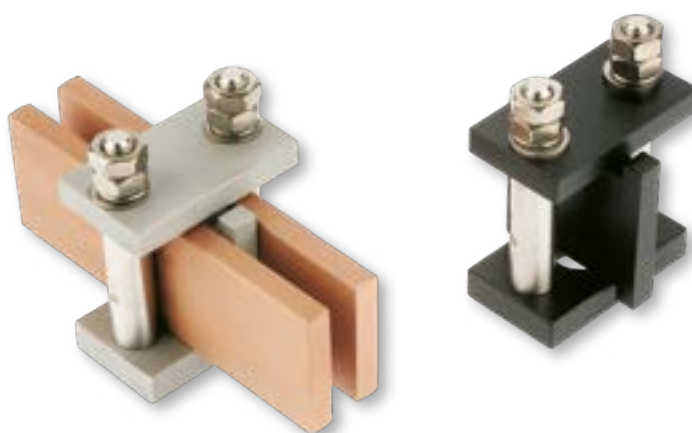
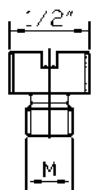

Deliverable threaded reducing-nipples made out of stainless-steel:

- Part-No. 16020 M 8
- 16021 M 10
- 16022 M 12
- 16023 M 16

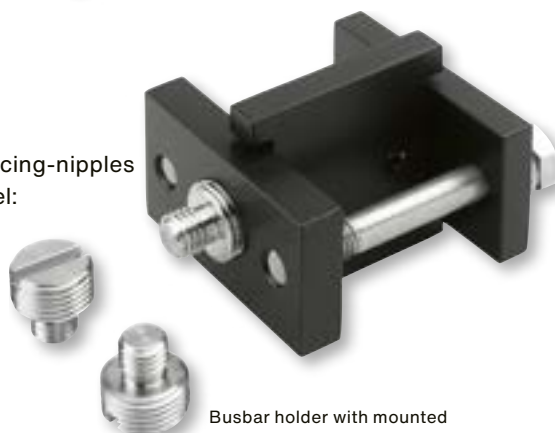

Busbar holder with mounted reducing thread nipple

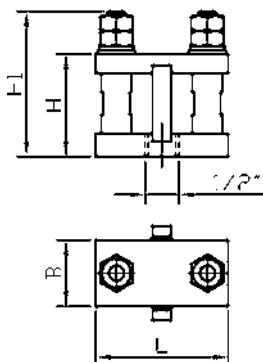
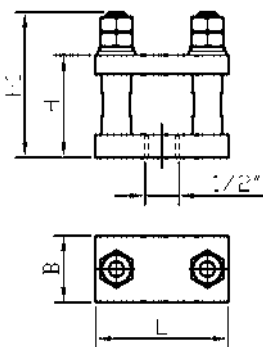

Part-No.		Technical data						
Type A	Type B	number	bar-width	thickness	L	dimensions mm		
						B	H	H <sub>1</sub>
16420	16540	1	30	3 - 20	70	35	54	77
16421	16541	1	40	3 - 20	70	35	64	87
16422	16542	1	50	5 - 20	70	40	74	97
16423	16543	1	60	5 - 20	70	40	84	107
16424	16544	1	80	5 - 20	70	40	109	132
16425	16545	1	100	5 - 20	80	50	129	157
16426	16546	1	120	5 - 20	80	50	149	177

Part-No.		Technical data						
Type A	Type B	number	bar-width	thickness	L	dimensions mm		
						B	H	H <sub>1</sub>
16430	16550	2	30	3 - 10	70	35	54	77
16431	16551	2	40	3 - 10	70	35	64	87
16432	16552	2	50	5 - 10	70	40	74	97
16433	16553	2	60	5 - 10	70	40	84	107
16434	16554	2	80	5 - 10	70	40	109	132
16435	16555	2	100	5 - 10	80	50	129	157
16436	16556	2	120	5 - 10	80	50	149	177

**Note:**

Dimensions in the table for busbar thickness 10 mm. For thinner busbars the dimension L is reduced. The then valid dimensions are available on request when specifying the changed busbar thickness.



## Busbar holders

**clamping version** for horizontal busbar guide  
suitable for mounting on insulators

Busbar holders for clamping one or two shorter busbars which should be firmly clamped in the holder in a horizontal position.

**Type A:** Suitable for aluminium-bars.  
Material of the holder Al MgSi 1,0.  
Fastening Material stainless-steel.

**Type B:** Suitable for copper-bars or outdoor installations.  
Material of the holder Al MgSi 1,0 with coated surface.  
Fastening material stainless-steel.

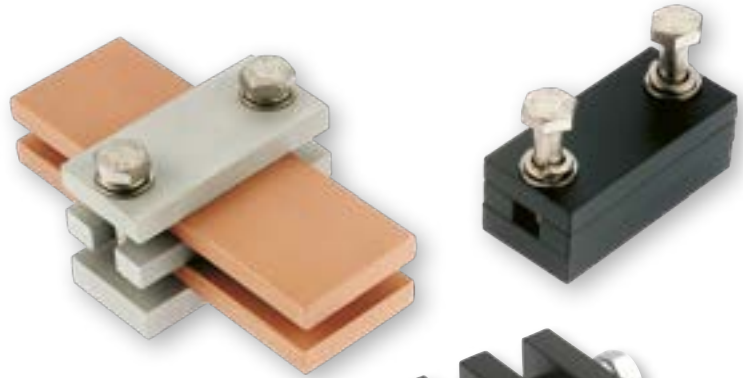

Deliverable threaded reducing-nipples made out of stainless-steel:

Part-No.	
16020	M 8
16021	M 10
16022	M 12
16023	M 16



Busbar holder with mounted reducing thread nipple

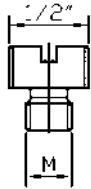

Busbar holder with mounted reducing thread nipple

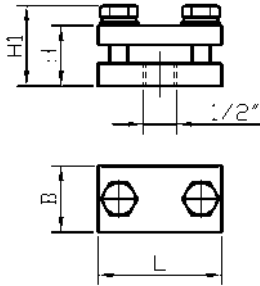

Part-No.		Technical data						
Type A	Type B	number	bar-width	thickness	L	dimensions mm		
						B	H	H <sub>1</sub>
15960/5	15980/5	1	30	5	65	35	27	38
15960/10	15980/10	1	30	10	65	35	32	43
15961/5	15981/5	1	40	5	75	35	27	38
15961/10	15981/10	1	40	10	75	35	32	43
15962/5	15982/5	1	50	5	85	40	27	38
15962/10	15982/10	1	50	10	85	40	32	43
15963/5	15983/5	1	60	5	95	40	27	38
15963/10	15983/10	1	60	10	95	40	32	43
15964/5	15984/5	1	80	5	115	40	27	38
15964/10	15984/10	1	80	10	115	40	32	43
15965/5	15985/5	1	100	5	145	50	35	48
15965/10	15985/10	1	100	10	145	50	40	53
15966/10	15986/10	1	120	10	165	50	40	53

Part-No.		Technical data						
Type A	Type B	number	bar-width	thickness	L	dimensions mm		
						B	H	H <sub>1</sub>
15970/5	15990/5	2	30	5	65	35	37	48
15970/10	15990/10	2	30	10	65	35	52	63
15971/5	15991/5	2	40	5	75	35	37	48
15971/10	15991/10	2	40	10	75	35	52	63
15972/5	15992/5	2	50	5	85	40	37	48
15972/10	15992/10	2	50	10	85	40	52	63
15973/5	15993/5	2	60	5	95	40	37	48
15973/10	15993/10	2	60	10	95	40	52	63
15974/5	15994/5	2	80	5	115	40	37	48
15974/10	15994/10	2	80	10	115	40	52	63
15975/5	15995/5	2	100	5	145	50	45	58
15975/10	15995/10	2	100	10	145	50	60	73
15976/10	15996/10	2	120	10	165	50	60	73

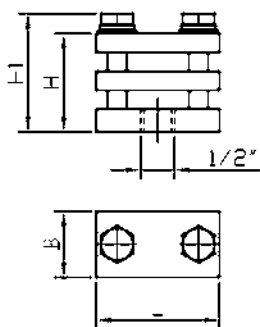

## Busbar holders

sliding version for horizontal busbar guide

suitable for mounting on insulators

Busbar holders for clamping one or two longer busbars which, because of the heat expansion, must stand in a sliding horizontal position in the holder. In this version, the upper clamping piece therefore does not rest on the busbar but on the bolt. Simply and time saving assembly option as the stud bolts can be screwed onto the insulator, prior to assembly, making it possible to simply insert the busbar during assembly.

**Type A:** Suitable for aluminium-bars.  
Material of the holder Al MgSi 1,0.  
Fastening material stainless-steel.

**Type B:** Suitable for copper-bars or outdoor installations.  
Material of the holder Al MgSi 1,0 with coated surface.  
Fastening material stainless-steel.

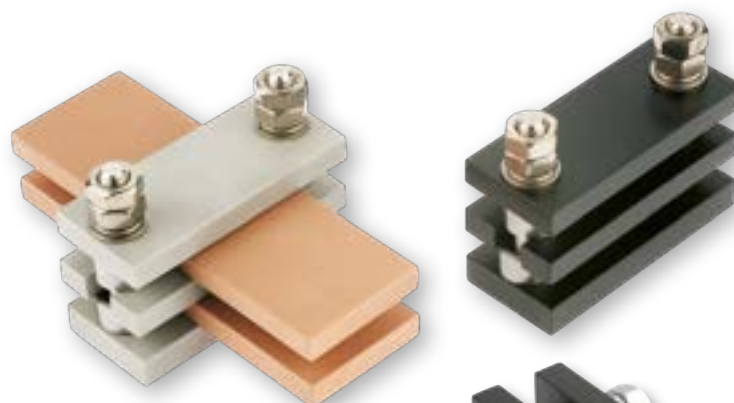
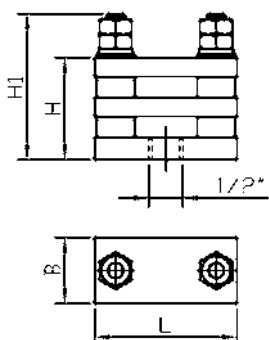
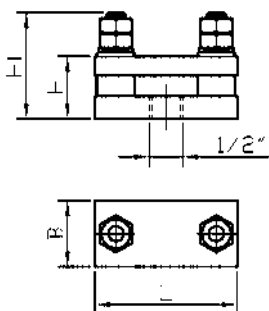
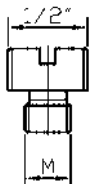

Deliverable threaded reducing-nipples made out of stainless-steel:

- Part-No. 16020 M 8
- 16021 M 10
- 16022 M 12
- 16023 M 16



Busbar holder with mounted reducing thread nipple

Part-No.		Technical data						
Type A	Type B	number	bar-width	thickness	L	dimensions mm		
						B	H	H <sub>1</sub>
16470/5	16580/5	1	30	5	75	35	28	56
16470/10	16580/10	1	30	10	75	35	33	56
16471/5	16581/5	1	40	5	85	40	28	56
16471/10	16581/10	1	40	10	85	40	33	56
16472/5	16582/5	1	50	5	95	40	28	56
16472/10	16582/10	1	50	10	95	40	33	56
16473/5	16583/5	1	60	5	105	40	28	56
16473/10	16583/10	1	60	10	105	40	33	56
16474/5	16584/5	1	80	5	135	50	36	69
16474/10	16584/10	1	80	10	135	50	41	69
16475/5	16585/5	1	100	5	155	50	36	69
16475/10	16585/10	1	100	10	155	50	41	69
16476/10	16586/10	1	120	10	175	50	41	69

Part-No.		Technical data						
Type A	Type B	number	bar-width	thickness	L	dimensions mm		
						B	H	H <sub>1</sub>
16480/5	16590/5	2	30	5	75	35	39	63
16480/10	16590/10	2	30	10	75	35	54	77
16481/5	16591/5	2	40	5	85	40	39	63
16481/10	16591/10	2	40	10	85	40	54	77
16482/5	16592/5	2	50	5	95	40	39	63
16482/10	16592/10	2	50	10	95	40	54	77
16483/5	16593/5	2	60	5	105	40	39	63
16483/10	16593/10	2	60	10	105	40	54	77
16484/5	16594/5	2	80	5	135	50	47	76
16484/10	16594/10	2	80	10	135	50	62	90
16485/5	16595/5	2	100	5	155	50	47	76
16485/10	16595/10	2	100	10	155	50	62	90
16486/10	16596/10	2	120	10	175	50	62	90

## Standoff insulators

made out of polyester resin material

with double hexagon spanner flats and threaded steel inserts

Insulators made of glass-fibre reinforced polyester resin suitable for indoor applications. They are characterized by their assembly-friendly double hexagonal design. For this reason, both the upper and the lower part of the insulator have a hexagonal spanner flat, which are arranged offset to each other. It is therefore possible to install and remove the insulators quickly and safely, even in confined spaces. In terms of costs, this reduces the assembly effort to a minimum.

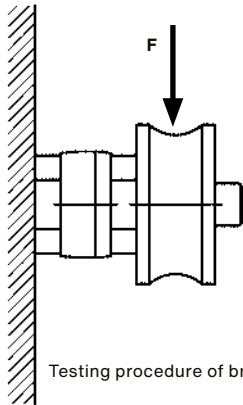
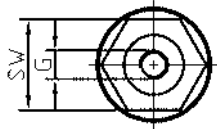
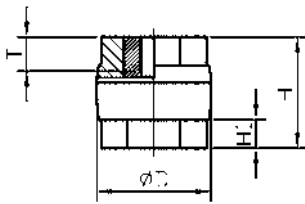

Testing procedure of breaking strength

### Technical data of the material

• Density	DIN 53479	1,75 g/cm <sup>3</sup>
• Flexural Resistance	DIN 53452/ISO R 178	120 N/mm <sup>2</sup>
• Impact Resistance	DIN 53455/ISO R 527	70 N mm <sup>2</sup>
• Impact Value	DIN 53453/ISO R179	45 KJm <sup>2</sup>
• Long Term/ Operational Temperature	VDE 0304, Part 21/IEC 216	+ 130 ° C
• Rod Behaviour	VDE 0304, Part 3	Step BH 2 ≤ 10
• Behaviour in case of Fire	UL 94	V-0
• Surface Resistance	DIN 53482	10 <sup>13</sup> Ω
• Throughout Resistance Dielectric	DIN 53482	10 <sup>14</sup> Ω . cm
• Loss Factor	DIN 53483	< 0,02 tan/50 Hz
• Deposit Tracking	DIN IEC 112/VDE 0303, Part 1	CT 600
• Water Absorption	DIN 53495	< 50 mg/1 d
• Colour	-	brown

The values in the table have been determined with our own standards based on DIN 53451 and combined with the standards for the respective materials for test purposes.

Part-No.	Technical data										
	dimensions mm					H <sub>1</sub>	PS/kV	BWS/kV	F/kN	Z/kN	weight kg/% pcs.
D	H	G	SW	T							
03068 S	30	30	M 6	24	8	9,5	5	0,75	3	6	5,70
03069 S			M 8								5,40
03070 S	30	40	M 6	24	10	10,0	5	1,00	4	8	7,30
03071 S	35	30	M 6	30	8	10,0	5	0,75	4	7	6,50
03072 S			M 8						5	8	6,10
03073 S	40	40	M 8	32	12	10,5	5	1,00	6	11	13,00
03074 S			M10		11						12,10
03075 S			M12		10						11,20
03080 S	40	50	M 8	32	12	10,5	10	1,50	5	11	16,50
13080 S			M10		15						16,50
03081 S			M12		13				7		13,80
13081 S	40	60	M 8	32	12	11,0	10	1,50	4	11	16,90
13082 S			M10		15						17,60
03078 S	50	40	M10	41	11	13,0	5	1,00	8	13	16,50
03079 S			M12		10				10		16,50
13083 S	50	50	M12	41	13	13,5	10	1,50	8	13	20,00
03084 S	50	60	M10	41	15	13,5	10	1,50	6	13	24,10
03085 S			M12		18				7		24,70
13084 S	60	60	M12	50	18	18,5	10	1,50	9	15	32,30
13085 S			M16		17				12	17	32,80

F = rated load on upper insulator edge  
Z = tensile force  
PS = testing voltage  
BWS = operating voltage

## Standoff insulators

made out of polyester resin material

with single hexagon spanner flat and threaded steel inserts

Standoff insulators manufactured out of a glass fibre reinforced polyester resin suitable for indoor applications. The characteristic of the material is in accordance with DIN Type 803. The compound is free of halogen with an excellent behaviour in case of fire (UL 94 V-0) and a very good strength of shape.

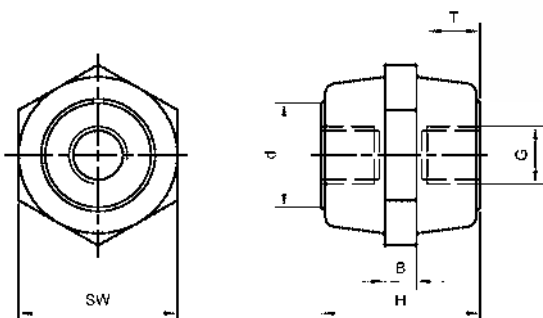

### Technical data of the material

- Strength of shape ISO 75 > 250° C
- Behaviour in case of fire UL 94 Class V-0 at 3,2 mm
- Density ISO 1183 1,75 g/cm<sup>3</sup>
- Special throughout resistance IEC 60093 10<sup>15</sup> Ohm
- Dielectric strength IEC 60243 20 kV/mm
- Deposit tracking IEC 60112 CTI 600
- Colour brown
- Temperature range - 40° C up to + 130° C

Part-No.	Technical data												
	H	SW	dimensions mm		d	B	Md/Nm	F/kN	Z/kN	D/kN	BWS/kV	PWS/kV	weight kg/% pcs.
06135	18	15	M 4	4,5	11	-	3,3	1,0	2	12	1,0	5	0,70
06138	20	20	M 5	5,5	14	5	5,0	1,3	3	20	1,0	5	1,20
06139	25	25	M 5	5,5	16	6	15,0	1,5	3	20	1,0	10	2,40
06140			M 6	8,0			15,0	1,5	5	35			2,40
06143	30	30	M 6	8,0	20	6	20,0	2,5	6	45	1,0	15	3,80
06144			M 8	10,0			40,0	3,0	12	60			5,40
06145			M10	11,0			50,0	4,0	12	60			6,60
06147	35	30	M 6	8,0	20	6	20,0	2,0	6	45	1,0	15	4,50
06148			M 8	10,0			40,0	3,5	12	60			6,00
06149			M10	11,0			50,0	4,0	16	75			7,00
06150	35	40	M 8	10,0	28	8	40,0	4,0	14	70	1,0	15	6,40
06151			M10	11,0			50,0	4,5	16	80			7,00
06152	40	30	M 6	8,0	20	6	20,0	1,5	6	45	2,0	20	5,00
06153			M 8	10,0			40,0	3,0	12	60			6,60
06154			M10	11,0			50,0	3,0	12	60			8,60
06156	40	40	M 8	10,0	28	8	50,0	5,0	14	90	2,0	20	10,00
06157			M10	14,0			90,0	8,0	20	100			12,20
06158			M12	12,5			100,0	9,0	22	120			13,50
06160	40	50	M 8	10,0	32	8	70,0	5,0	14	140	2,0	20	13,80
06161			M10	14,0			120,0	12,5	23	140			16,00
06162			M12	18,0			200,0	12,5	28	180			17,00
06165	50	40	M 8	10,0	28	10	50,0	5,0	14	90	3,0	25	12,00
06166			M10	14,0			90,0	5,0	20	100			14,00
06167			M12	18,0			100,0	6,0	22	120			16,00
06169	50	50	M 8	10,0	32	10	70,0	4,5	14	120	3,0	25	17,50
06170			M10	14,0			120,0	10,0	23	140			20,00
06171			M12	18,0			180,0	10,0	28	180			21,50
06172			M16	16,0			180,0	10,0	28	180			23,90
06174	60	40	M 8	10,0	28	8	50,0	4,0	14	90	3,0	25	14,00
06175			M10	14,0			90,0	6,0	20	100			16,00
06176			M12	18,0			120,0	6,0	20	100			18,00
06178	60	50	M10	14,0	32	10	120,0	9,0	23	140	3,0	25	23,00
06179			M12	18,0			200,0	11,0	28	180			25,00
06182	60	60	M12	18,0	40	12	200,0	12,0	28	220	3,0	25	33,00
06183			M16	21,0			300,0	15,0	32	240			35,00
06184			M20	22,0			300,0	16,0	37	240			38,60
06185	80	60	M10	14,0	40	12	200,0	11,0	32	220	3,0	25	41,00
06186			M12	18,0			300,0	15,0	37	240			43,00
06187			M16	21,0			300,0	15,0	37	240			45,00

Part-No. 06135 Cylindrical design without spanner flat

SW = wrench size

PWS = testing voltage (AC)

Md/Nm = permissible tightening torque

T = usable thread depth

Z = tensile force

BWS = operating voltage

F = rated load limit on upper insulator edge

D = compressive force



## Standoff insulators made out of Polyamide

with single hexagon spanner flat and steel inserts

Standoff insulators manufactured out of reinforced, flame protected and heat stabilized Polyamide suitable for indoor applications. The compound is free of halogen and Phosphor. The material can be converted efficiently and is characterized by his excellent values for tensile strength (Z) and the rated load limit on the upper insulator edge (F). The differences to the design made out of glass fibre reinforced polyester resin are basically in the values for the behaviour in case of fire (class V2 to V-0) and the temperature range - 25° C up to + 120° C to - 40° C up to + 130° C.

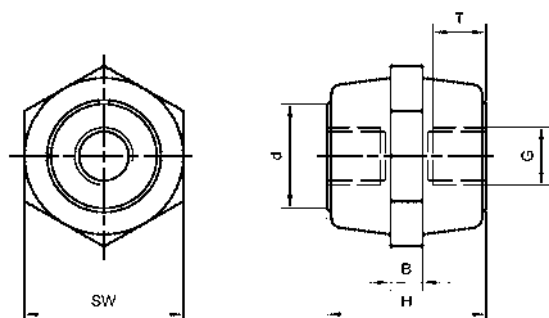

### Technical data of the material

- |                             |                        |                        |
|-----------------------------|------------------------|------------------------|
| • Behaviour in case of fire | UL 94                  | Class V2               |
| • Density                   | ISO 1183               | 1,36 g/cm <sup>3</sup> |
| • Dielectric strength       | IEC 60243-1            | 30 kV/mm               |
| • Deposit tracking          | IEC 60112              | CTI 475                |
| • Colour                    | nature                 |                        |
| • Temperature range         | - 25° C up to + 120° C |                        |

Part-No.	Technical data												
	dimensions mm						Md/Nm	F/kN	Z/kN	D/kN	BWS/kV	PWS/kV	weight kg/% pcs.
	H	SW	G	T	d	B							
06100	18	15	M 4	4,5	11	3	3,3	1,0	2	12	1,0	5	0,60
06102	25	25	M 5	5,5	16	6	15,0	2,0	3	20	1,0	10	2,00
06103			M 6	8,0			15,0	2,0	5	35			2,00
06105	30	30	M 6	8,0	20	6	20,0	3,0	6	45	1,0	15	3,00
06106			M 8	10,0			40,0	4,0	12	60			5,00
06107			M10	11,0			50,0	8,0	14	60			6,40
06109	35	30	M 6	8,0	20	6	20,0	5,0	6	45	1,0	15	5,00
06110			M 8	10,0			40,0	5,0	12	60			6,00
06111			M10	11,0			50,0	5,0	16	75			6,00
06112	35	40	M 8	10,0	28	8	40,0	4,0	14	70	1,0	15	6,50
06113			M10	11,0			50,0	4,5	16	80			6,70
06114	40	30	M 6	8,0	20	6	20,0	1,5	6	45	2,0	20	7,40
06114/8			M 8	10,0			40,0	5,0	12	60			7,80
06115	40	40	M 8	10,0	28	8	50,0	7,0	14	90	2,0	20	8,00
06116			M10	14,0			90,0	10,0	28	100			10,00
06117			M12	12,5			100,0	12,0	22	120			10,00
06120	50	40	M 8	10,0	28	10	50,0	5,0	14	90	3,0	25	10,00
06121			M10	14,0			90,0	5,0	20	100			12,00
06122			M12	18,0			100,0	6,0	22	120			14,00
06125	50	50	M10	14,0	38	10	120,0	10,0	23	140	3,0	25	18,00
06126			M12	18,0			160,0	14,0	28	180			19,50
06127			M16	16,0			200,0	18,0	29	180			21,10
06129	60	40	M 8	10,0	28	8	50,0	4,0	14	90	3,0	25	12,00
06130			M10	14,0			90,0	6,0	20	100			14,00
06131			M12	18,0			120,0	6,0	20	100			14,80

SW = wrench size

T = usable thread depth

F = rated load limit on upper insulator edge

PWS = testing voltage (AC)

Z = tensile force

D = compressive force

Md/Nm = permissible tightening torque

BWS = operating voltage

### Highly flexible power connections made out of copper braids or round stranded copper cables

Extensive technical possibilities for special solutions:

- extremely flexible components
- both consisting out of braided copper tapes as well as round stranded copper cables
- optionally made of uncoated or tinned wires
- optionally with or without insulation
- on request with coated contact areas
- in connection widths from 20 mm up to 200 mm
- in cross-sections from 25 up to 6000 mm<sup>2</sup>

### Flexible connectors made out of copper- or aluminium foils

- as expansion connector
- with application - specific adapted connection areas and shapes
- also available with tin- or silver-plated surfaces on request
- also in extruded design as insulated supple bars

## Flexible power connections

Flexible power connections are used within a busbar system to compensate for dimensional differences and thermal expansions. Additionally they are used as electrical connections between transformers, generators and switchgears with the busbar system. In this way vibrations or switching shocks can also be compensated for in addition to dimensional difference compensation. Such flexible connections can be manufactured as highly flexible current connectors made out of flat or round strands or as flexible foil connectors made of layered foils.

Highly flexible stranded connectors allow a 3D-movement but have a slightly larger installation volume than comparable foil connectors. Foil connectors are not so flexible as the highly flexible stranded connectors and have only a 2-dimensional limited mobility. However, they only require a relatively small installation space and are often cheaper to produce. All designs can be modified in terms of cross-sections and connection widths. They can also be supplied with insulation adapted to the respective installation situation.

## Highly flexible stranded connectors

druseidt stranded connectors are extremely flexible components made of flat or round E-copper/Copper-ETP strands with a single wire diameter of 0,07 or 0,10 mm. Due to the use of wires with this small single wire diameter as well as the construction of different layers of flat stranded tapes, druseidt power connectors are characterized not only by their high flexibility but also by a very large conductor surface. They thus enable the production of electrical connections with high current capacity. Seamless E-Copper/Copper-ETP sleeves are solderless crimped at the ends under high pressure.

The special druseidt-crimp technology enables a high degree of compression and forming and thus the production of extremely compacted contact areas. In this process, the entire contact surface is pressed compactly over a large area together with the strands. Due to the very high pressure during the crimping process, which amounts to several hundred tons of pressure, depending on the size of the contact surfaces and in conjunction with the process technology, developed by druseidt, the air components are pressed out of the spaces between the individual wires to such an extent that components with extremely favourable and optimized electrical contact- and connection resistances are produced.



## Flexible foil connectors

druseidt foil connectors consist of a number of layers of copper or aluminium foils with thickness e.g. 0,2 or 0,3 mm. Various manufacturing processes are available for the production, shaping and design of the connection areas. The connection areas of standard expansion connectors made of copper are produced in a press-welded design. Pressure welding is a special resistance welding process that enables entire surfaces to be welded compactly and safely without the use of any kind of other welding additives. The heating during the welding process is generated by means of current and the material of the copper connectors, which represents a resistance. The individual foils of the workpiece are then jointed together in the connection area under pressure.

The welded connection will be realized by diffusion processes (so-called grain diffusion, i.e. intergrowth of the crystals of adjacent foils) when the foils of the heated workpiece are deformed and pressed together so that a perfect molecular structure of the contact area is created. The middle expansion part of the connector still remains flexible. The pressure welding process cannot be used for aluminium connectors, foil connectors with contact areas of different widths on both sides or larger angled contact areas. Such connectors are manufactured by means of inert gas welded and welded-on solid contact pieces. These processes can also be used to weld clamping devices, suitable for connection to pipes or round bolts, to flexible foil expansion parts.





## We manufacture flexible power connections coordinated to the individual application case

We manufacture flexible connectors from the smallest ground strap up to cross-sections of several thousands mm<sup>2</sup> in air- and water-cooled design. The braided tapes and round stranded ropes, used as base material for our connectors, are also manufactured in our company and are available in rolls or spools by the metre too.

Detailed information about this product range can be found in our special catalogue no. 2 "Highly flexible air- and water-cooled connectors and cables for Hi-tech applications", which we will be happy to send you on request.





## Highly flexible copper connectors

in solderless pressed design

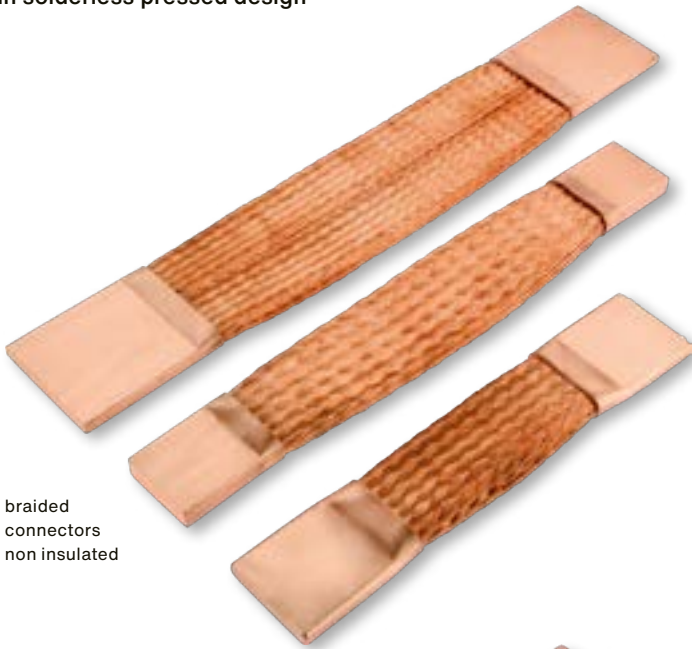

braided  
connectors  
non insulated



braided  
connectors  
with standard PVC-insulation

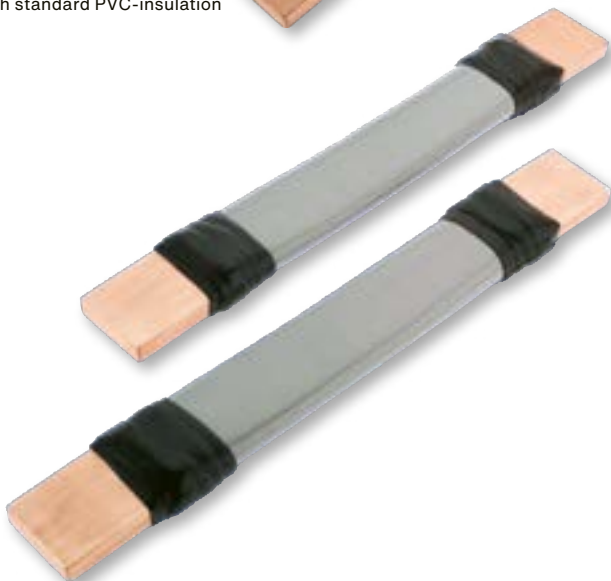

braided  
connectors  
PVC insulated and liquid protected

### Standard design

Uncoated E-Copper braid, highly flexible (wire Ø 0,07/0,10 mm) with solderless pressed contact areas made out of uncoated, seamless E-Copper/Copper-ETP tubes.

### Contact areas

Contact areas rectangular with bending protection (standard). Without or bending protection only on one side on request. It is also possible to change the lengths and the widths of all contact areas. In special design we deliver connectors with contact area width 140/150/160/180 and 200 mm too.

### Drilling

Standard design without drilling. Drilling on request according to druseidt-type I-III or customer requirements.

### Lengths

Individual acc. to customer requirements.

### Insulation

Insulated design on request. Standard material is a PVC-hose. Materials like silicone, glass-fibre- or shrinking tubes etc. on request.

### Liquid protected design

Additional liquid protected design on request.

### Special designs

In special design we deliver also connectors made out of tinned wires or with coated contact areas (tin-, nickel-, silver- or gold plated) or in coordination with your application according to your drawings/samples or wishes.

### When placing an order please specify

- druseidt-Part-No.
- total length
- If drilling is needed either druseidt-design I-III or acc. to your drawings or sketches.
- If insulation hoses are needed please add the word insulated behind the part-no. If you need another insulation material like PVC please specify this in your order.
- If you need an additional protection against liquids please add the remark with liquid protection.
- If connections with surface coated contact areas are required, please specify (type of coating and possibly desired layer thicknesses)

## Highly flexible copper connectors in solderless pressed design 25-4500 mm<sup>2</sup>

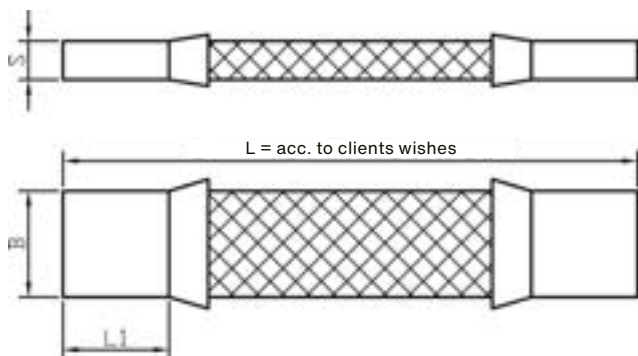

### Technical data

**Braids:**

- made out of annealed Cu-ETP1-wires
- soft annealed
- uncoated surface is standard
- tinned surface on request
- wire-Ø 0,10 mm

**Contact areas:**

- seamless Cu-ETP-tube
- uncoated surface is standard
- tin-, nickel-, silver-coated surface on request

**Insulation:**

- PVC-hose (standard)
- Silicone-, glass-fibre-, shrinking tubes or others on request

Part-No.	Technical data						standard drilling patterns
	cross-section mm <sup>2</sup>	dimensions ca. mm			current-load Ampere		
		B	L <sub>1</sub>	S	DC	AC	
02930	25	20	20	3,5	150	140	<b>Type I</b> 
02931	50			5,0	250	240	
02932	75			6,4	350	340	
02933	100			8,0	400	380	
02934	25	25	25	3,3	150	140	
02935	50			4,5	300	280	
02936	75			5,5	350	340	
02937	100			6,6	450	420	
02938	125			7,8	500	470	
02939	50	30	30	4,0	300	290	
02940	75			5,0	400	390	
02941	100			5,8	450	440	
02942	150			8,5	550	540	
02943	200			10,7	650	640	
02944	300			14,1	800	790	
02945	100	40	40	6,9	500	480	
02946	150			7,1	600	590	
02947	200			8,4	700	680	
02948	250			9,8	800	780	
02949	300			11,7	900	850	
02950	400			13,9	1000	980	
02951	140	50	50	6,0	650	630	<b>Type II</b> 
02952	210			7,4	800	780	
02953	280			9,0	950	900	
02954	420			13,1	1050	1000	
02955	560			16,2	1350	1200	
02956	140	60	60	6,5	700	680	
02957	210			7,9	900	850	
02958	350			10,4	1150	1100	
02959	490			13,1	1350	1300	
02960	560			14,6	1400	1350	
02961	340	80	80	8,9	1200	1100	<b>Type III</b> 
02962	520			10,9	1500	1400	
02963	700			13,7	1700	1600	
02964	840			15,5	1900	1800	
02965	1000			18,7	2100	1950	
02966	500	100	100	10,0	1600	1500	
02967	670			11,5	1850	1790	
02968	860			14,0	2100	2000	
02969	1000			16,5	2250	2150	
02970	1200			19,0	2450	2350	
02971	1500			22,5	2700	2550	
02972	610	120	120	10,8	1900	1750	
02973	1000			14,8	2650	2500	
02974	1540			20,0	3400	3200	
02975	2000			24,5	3950	3800	
02976	3000			34,0	4800	4550	
02977	4500			49,0	5400	5400	

**Remark:**

All information about current-load are approximate values for a non insulated design. The reducing factor for an insulated design depending on the application is between 15-20 %. Please notice that the temperature of the conductor is in dependent on the installation, the application, the cooling, the ambient temperature etc. So that if necessary reducing factors are to be considered. With pleasure our employees assist your company in finding optimal solutions.

## Air cooled high current cables made out of stranded copper cables

with and without insulation,  
in solderless pressed design

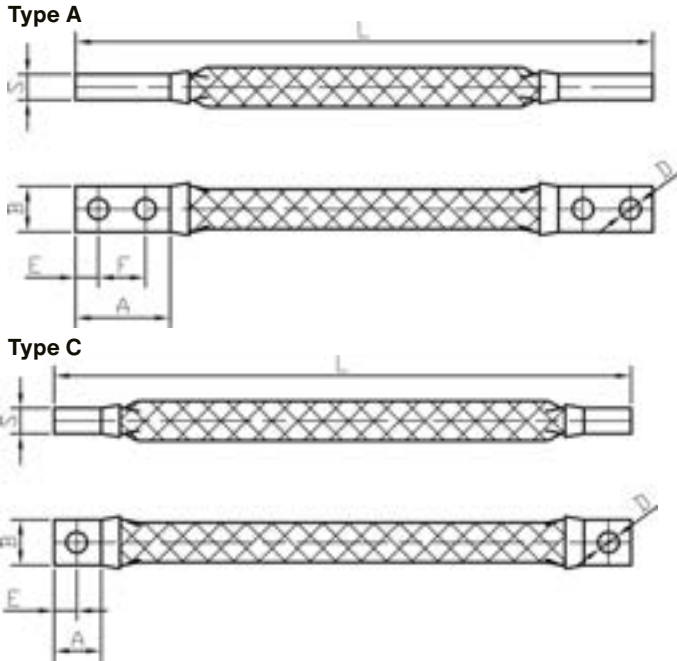

### Standard design

Manufactured out of highly flexible round stranded copper cables with bare wires, wire-Ø 0,10 mm (standard) or 0,30 mm on request. With solderless pressed contact areas made out of uncoated, seamless E-Copper/copper-ETP tubes.

### Contact areas

Contact areas rectangular with bending protection (standard). Without or bending protection only on one side on request. On request it is also possible to change the length of all contact areas.

### Drilling

Standard drilling acc. to type A or C or acc. to your wishes.

### Length

According to your wishes.

### Insulation

Standard insulation material is a PVC-hose. Other materials like silicone, glass-fibre- or shrinking tubes etc. on request.

### Special designs

In special design we deliver also connectors made out of tinned wires or with coated contact areas (tin-, nickel-, silver- or gold plated) or in coordination with your application according to your drawings, samples or wishes.

	Part-No.		Technical data									
			cross-section mm <sup>2</sup>	current- load	dimensions mm							
	unin- sulated	PVC- insulated			A	B	D	E	F	S	L	
Type A	15378	15448	70	300 A	30	15	7	7,5	15	8,5	According to your wishes.	
	15379	15449	95	360 A	40	20	9	10,0	20	8,2		
	15380	15450	120	420 A	40	20	9	10,0	20	10,0		
	15391	15451	150	480 A	50	25	11	12,5	25	11,5		
	15381	15452	185	570 A	50	25	11	12,5	25	13,5		
	15382	15453	240	670 A	60	32	11	16,0	32	12,8		
	15383	15454	300	780 A	80	40	14	20,0	40	13,3		
	15384	15455	400	950 A	80	40	14	20,0	40	15,5		
	15385	15456	500	1100 A	80	40	14	20,0	40	23,5		
	15386	15457	600	1250 A	80	55	14	20,0	40	18,8		
	15387	15458	700	1375 A	80	55	14	20,0	40	20,2		
	15388	15459	750	1450 A	80	55	14	20,0	40	21,8		
15389	15460	850	1550 A	80	55	14	20,0	40	22,3			
15390	15461	1000	1800 A	80	55	14	20,0	40	26,9			
Type C	15398	15465	70	300 A	15	15	7	7,5	-	8,5	According to your wishes.	
	15399	15466	95	360 A	20	20	9	10,0	-	8,2		
	15400	15467	120	420 A	20	20	9	10,0	-	10,0		
	15411	15468	150	480 A	25	25	11	12,5	-	11,5		
	15401	15469	185	570 A	25	25	11	12,5	-	13,5		
	15402	15470	240	670 A	32	32	11	16,0	-	12,8		
	15403	15471	300	780 A	40	40	14	20,0	-	13,3		
	15404	15472	400	950 A	40	40	14	20,0	-	15,5		
	15405	15473	500	1100 A	40	40	14	20,0	-	23,5		
	15406	15474	600	1250 A	40	55	14	20,0	-	18,8		
	15407	15475	700	1375 A	40	55	14	20,0	-	20,2		
	15408	15476	750	1450 A	40	55	14	20,0	-	21,8		
15409	15477	850	1550 A	40	55	14	20,0	-	22,3			
15410	15478	1000	1800 A	50	55	14	20,0	-	26,9			

### Remark:

All information about current-load are approximate values for single laying of air cooled cables and ambient temperature + 35° C and a conductor temperature of circa + 70° C. The temperature of the conductor is in dependent on the installation, the application, the cooling, the ambient temperature etc. so that if necessary reducing factors are to be considered. The reducing factor for an insulated design depending on the application is between 15-20 %.

## Air cooled high current cables made out of stranded copper cables

with and without insulation,  
in solderless pressed design

### Type A

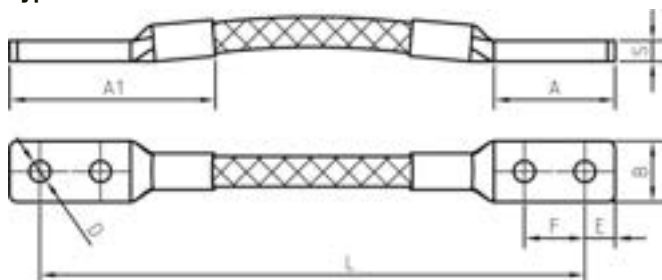

### Type C

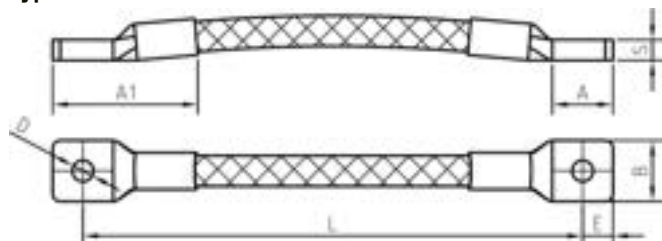

### Standard design

Manufactured out of highly flexible round stranded copper cables with bare wires, wire-Ø 0,10 mm (standard) or 0,30 mm on request. With solderless pressed contact areas made out of uncoated, seamless E-Copper/copper-ETP tubes.

### Contact areas

Contact areas shaped like a cable lug, so that two cables can also be mounted against each other on one connection bar.

### Drillings

Standard drilling according to type A or C or according to your wishes.

### Lengths

According to your wishes.

### Insulation

Standard insulation material is a PVC-hose. Other materials like silicone, glass-fibre or shrinking tubes etc. on request.

### Special designs

In special design we deliver also connectors made out of tinned wires or with coated contact areas (tin-, nickel-, silver- or gold plated) or in coordination with your application according to your drawings, samples or wishes.

	Part-No.		Technical data									
	unin- sulated	PVC- insulated	cross-section mm <sup>2</sup>	current- load	dimensions mm							
					A	A <sub>1</sub>	B	D	E	F	S	L
Type A	14645	14700	70	300 A	30	50	15	7	7,5	15	8,5	According to your wishes.
	14646	14701	95	360 A	40	70	20	9	10,0	20	8,2	
	14647	14702	120	420 A	40	70	20	9	10,0	20	11,0	
	14648	14703	150	480 A	50	80	25	11	12,5	25	11,5	
	14649	14704	185	570 A	50	80	25	11	12,5	25	13,0	
	14650	14705	240	670 A	60	90	32	11	16,0	32	12,5	
	14651	14706	300	780 A	80	135	40	14	20,0	40	13,5	
	14652	14707	400	950 A	80	135	40	14	20,0	40	15,5	
	14653	14708	500	1100 A	80	135	40	14	20,0	40	22,0	
	14654	14709	600	1250 A	80	135	55	14	20,0	40	17,0	
	14655	14710	750	1450 A	80	135	55	14	20,0	40	21,0	
	14656	14711	850	1550 A	80	135	55	14	20,0	40	22,3	
14657	14712	1000	1800 A	80	135	60	14	20,0	40	24,5		
Type C	14660	14715	70	300 A	15	35	15	7	7,5	-	8,5	According to your wishes.
	14661	14716	95	360 A	20	50	20	9	10,0	-	8,2	
	14662	14717	120	420 A	20	50	20	9	10,0	-	11,0	
	14663	14718	150	480 A	25	55	25	11	12,5	-	11,5	
	14664	14719	185	570 A	25	55	25	11	12,5	-	13,0	
	14665	14720	240	670 A	32	62	32	11	16,0	-	12,5	
	14666	14721	300	780 A	40	95	40	14	20,0	-	13,5	
	14667	14722	400	950 A	40	95	40	14	20,0	-	15,5	
	14668	14723	500	1100 A	40	95	40	14	20,0	-	22,0	
	14669	14724	600	1250 A	40	95	55	14	20,0	-	17,0	
	14670	14725	750	1450 A	40	95	55	14	20,0	-	21,0	
	14671	14726	850	1550 A	40	95	55	14	20,0	-	22,3	
14672	14727	1000	1800 A	50	105	60	14	20,0	-	24,5		

### Remark:

All information about current-load are approximate values for single laying of air cooled cables and ambient temperature + 35° C and a conductor temperature of circa + 70° C. The temperature of the conductor is in dependent on the installation, the application, the cooling, the ambient temperature etc. so that if necessary reducing factors are to be considered. The reducing factor for an insulated design depending on the application is between 15-20 %.





## Flexible expansion connectors

Material: copper HCP-foils

Contact areas: press welded



Expansion connectors in standard design. The width and the thickness of the contact areas are in coordination with the usual dimensions of the traditional busbar systems. With drilling on request, e.g. according to DIN 43673 page 1 + 2, DIN 46206 page 2 or according to your drawings/samples or wishes. On request it is also possible to deliver expansion connectors with other dimensions or in bended design according to your drawings as well as with coated contact areas (e.g. tinned or silvered).

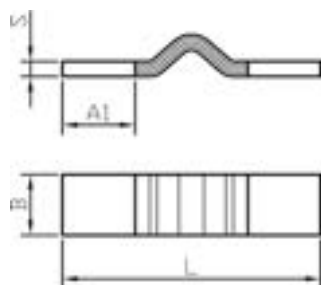

Part-No.	Technical data					weight kg/pcs.
	cross-section mm <sup>2</sup>	B	A <sub>1</sub>	S	L	
15730	200	40	40	5	230	0,48
15731	320	40	40	8	230	0,77
15732	400	40	40	10	230	0,96
15733	480	40	40	12	230	1,15
15734	600	40	40	15	230	1,28
15735	800	40	40	20	230	1,92
15736	250	50	50	5	250	0,65
15737	400	50	50	8	250	1,04
15738	500	50	50	10	250	1,30
15739	600	50	50	12	250	1,55
15740	750	50	50	15	250	1,95
15741	1000	50	50	20	250	2,60
15742	300	60	60	5	270	0,83
15743	480	60	60	8	270	1,33
15744	600	60	60	10	270	1,66
15745	720	60	60	12	270	1,99
15746	900	60	60	15	270	2,51
15747	1200	60	60	20	270	3,32
15748	400	80	80	5	310	1,25
15749	640	80	80	8	310	1,99
15750	800	80	80	10	310	2,50
15751	960	80	80	12	310	3,01
15752	1200	80	80	15	310	3,75
15753	1600	80	80	20	310	5,00
15754	500	100	100	5	350	1,74
15755	800	100	100	8	350	2,81
15756	1000	100	100	10	350	3,48
15757	1200	100	100	12	350	4,17
15758	1500	100	100	15	350	5,27
15759	2000	100	100	20	350	6,96
15760	2500	100	100	25	350	8,70
15761	600	120	120	5	390	2,26
15762	960	120	120	8	390	3,68
15763	1200	120	120	10	390	4,52
15764	1440	120	120	12	390	5,50
15765	1800	120	120	15	390	6,97
15766	2400	120	120	20	390	9,04
15767	3000	120	120	25	390	11,57
15768	800	160	160	5	470	3,64
15769	1280	160	160	8	470	5,99
15770	1600	160	160	10	470	7,28
15771	1920	160	160	12	470	8,72
15772	2400	160	160	15	470	11,02
15773	3200	160	160	20	470	14,56
15774	4000	160	160	25	470	18,26
15775	4800	160	160	30	470	21,84

### Remark:

The minimum current capacity of expansion connectors is in accordance with the values of solid busbars (cf. DIN 43671 resp. DIN 46276 part 1 + 2).

## Flexible expansion connectors

Material: aluminium foils

Contact areas: inert gas welded

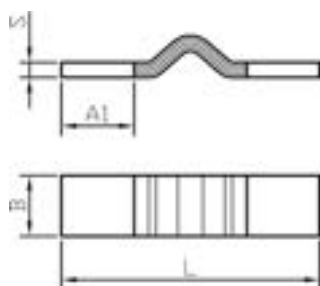

Expansion connectors in standard design. The width and the thickness of the contact areas are in coordination with the usual dimensions of the traditional busbar-systems. With drilling on request, e.g. according to DIN 43673 page 1 + 2, DIN 46206 page 2 or according to your drawings/samples or wishes. On request it is also possible to deliver expansion connectors with other dimensions or in bended design according to your drawings.

**Remark:**

The minimum current capacity of expansion connectors is in accordance with the values of solid busbars (cf. DIN 43670 resp. DIN 46276 part 1 + 2).

Part-No.	Technical data					weight kg/pcs.
	cross-section mm <sup>2</sup>	B	A <sub>1</sub>	S	L	
03030	200	40	40	5	250	0,16
03031	400	40	40	10	250	0,32
03032	600	40	40	15	250	0,48
03033	200	40	80	5	280	0,18
03034	400	40	80	10	280	0,36
03035	600	40	80	15	310	0,57
03036	250	50	50	5	270	0,22
03037	500	50	50	10	270	0,43
03038	250	50	80	5	300	0,25
03039	500	50	80	10	300	0,47
03040	750	50	80	15	310	0,71
03041	300	60	60	5	290	0,28
03042	600	60	60	10	290	0,55
03043	300	60	80	5	300	0,29
03044	600	60	80	10	300	0,56
03045	900	60	80	15	310	0,87
03046	800	80	80	10	330	0,82
03047	1200	80	80	15	330	1,30
03048	1000	100	100	10	370	1,20
03049	1500	100	100	15	370	1,70
03050	1200	120	120	10	410	1,50
03051	1800	120	120	15	410	2,20
03052	1600	160	160	10	490	2,30

## Flexible transformer connections with expansion part

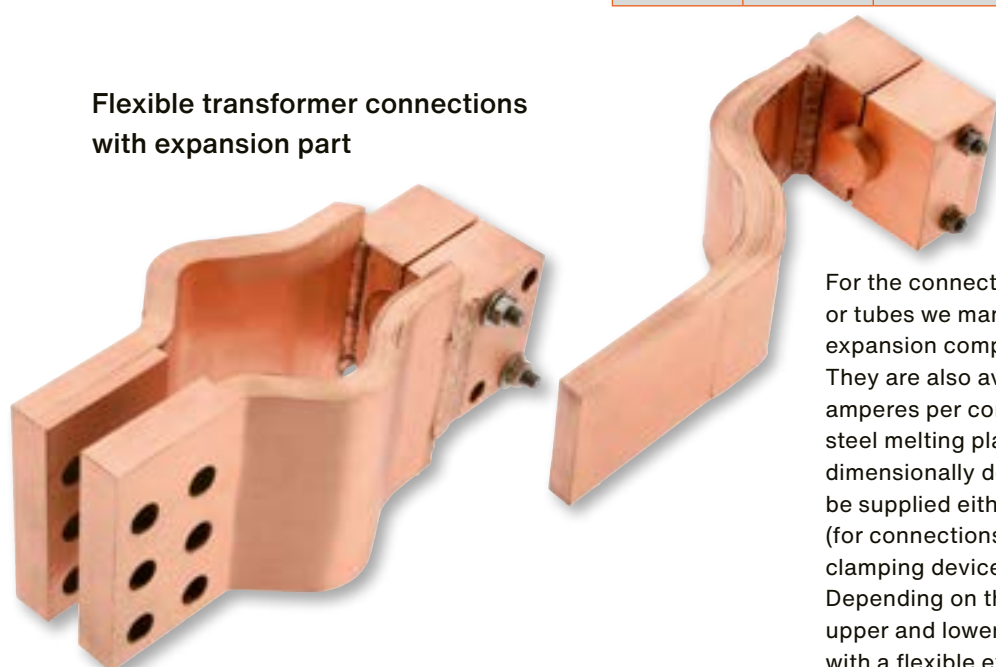

For the connection of transformers with outlets as round bolts or tubes we manufacture flexible connections made with expansion compensation part and welded clamping device. They are also available for power ratings of several thousand amperes per connection, e.g. for power transformers inside of steel melting plants and similar application. The connections are dimensionally designed individually for the transformer and can be supplied either with a clamp on one side and flat connection (for connections to busbar systems or contact plates) or with a clamping device on both sides for connections to pipe systems. Depending on the capacity and the required cross-section, the upper and lower parts of the clamping device can be equipped with a flexible expansion part. It is also possible to combine the upper part with a flexible expansion part and the lower part only as a loose clamping piece.

## PVC-insulated supple bars

Material: Cu-ETP uncoated or tinned  
insulated by a black vinyl compound in lengths á 2 m

### Construction and application

Supple bars are insulated flat electrical conductors. They consist of several layers of uncoated or tin plated Cu-ETP strips (99,9 % copper) and are insulated with a flexible high quality vinyl compound.

This special compound is self-extinguishing and free of lead. The flexibility of the bars offers an installation into difficult

equipment or small places. They have become particularly well established as connectors in switchgears and between transformers, generators, switching devices and pre-fabricated power systems up to an operating voltage of 1 kV. As a consequence of their large surface area and their favorable thermal radiation properties, they transmit larger current loads than solid busbars of the same cross-section. So it is possible to use components with smaller dimensions. The elasticity of the vinyl compound realizes a deforming of busbars also when working with larger cross-sections.

By bending and twisting it is also possible to change the connection level in a minimum of space.

Our supple bars enable an individual fitting of the components, a reduction of the cross-section and a reduction of the installation time. So they are a very interesting cost-saving product.

### Technical data

#### Electrical conductor:

- copper strips Cu-ETP (99,9 % copper)
- surface uncoated or tinned
- stability  $> 200 \text{ N/mm}^2$
- electrical conductivity  $57 \text{ S x m/mm}^2$

#### Insulation:

- special vinyl compound
- black, free of lead
- thickness 1,8-2 mm
- self-extinguishing acc. to UL 94 V0
- shore hardness 85 A
- elasticity 365 %
- AC voltage between potential and insulating material 16,5 kV
- AC voltage between two insulated supple bars in contact 33 kV
- operating voltage max. 1 kV
- operating temperature  $- 20^\circ \text{ C}$  up to  $+ 105^\circ \text{ C}$

#### Delivery lengths:

- standard lengths 2 m
- other lengths e.g. 3 m on request

### Supple bars with halogen-free insulation on request

### Installation

Simple mounting by drilling, punching or underside clamping. The copper strips are sliding when bending the bars, therefore it is necessary to bend the bars before starting the cutting, drilling or punching process.

To prevent a displacement of the copper strips a tightly clamping of the bars is necessary too when carrying out the drilling or punching process.



## PVC-insulated supple bars

Part-No.		Technical data							
uncoated	tinned	cross-section mm <sup>2</sup>	copper-strips number x dimension mm	current load in dependence of the conductor heat in °C					copper-weight kg/% m
				65°	75°	85°	95°	105°	
15650	15650 vz	14,4	2 x 9,0 x 0,8	95 A	114 A	130 A	144 A	157 A	13,80
15651	51700*	21,6	3 x 9,0 x 0,8	119 A	141 A	162 A	180 A	196 A	20,70
15652	15652 vz	28,8	4 x 9,0 x 0,8	139 A	166 A	190 A	211 A	230 A	27,60
15653	15653 vz	36,0	5 x 9,0 x 0,8	158 A	189 A	215 A	240 A	262 A	34,50
15654	51705*	43,2	6 x 9,0 x 0,8	176 A	210 A	240 A	266 A	291 A	41,40
15655	15655 vz	13,0	2 x 13,0 x 0,5	97 A	116 A	132 A	147 A	160 A	12,50
15656	51710*	19,5	3 x 13,0 x 0,5	120 A	143 A	163 A	181 A	198 A	18,70
15657	15657 vz	26,0	4 x 13,0 x 0,5	140 A	166 A	190 A	211 A	231 A	25,00
15658	51715*	39,0	6 x 13,0 x 0,5	174 A	207 A	237 A	263 A	288 A	37,50
15661	15661 vz	24,8	2 x 15,5 x 0,8	141 A	168 A	192 A	214 A	234 A	23,80
15662	51720*	49,6	4 x 15,5 x 0,8	205 A	244 A	279 A	310 A	339 A	47,60
15663	51725*	74,4	6 x 15,5 x 0,8	257 A	306 A	350 A	389 A	424 A	71,40
15664	15664 vz	99,2	8 x 15,5 x 0,8	303 A	361 A	412 A	458 A	501 A	95,20
15665	51730*	124,0	10 x 15,5 x 0,8	345 A	411 A	470 A	523 A	571 A	119,00
15666	15666 vz	40,0	2 x 20,0 x 1,0	193 A	230 A	263 A	292 A	319 A	38,30
15667	15667 vz	60,0	3 x 20,0 x 1,0	240 A	286 A	326 A	363 A	396 A	57,50
15668	15668 vz	80,0	4 x 20,0 x 1,0	280 A	334 A	381 A	424 A	463 A	76,60
15669	15669 vz	100,0	5 x 20,0 x 1,0	317 A	377 A	431 A	479 A	523 A	95,80
15670	15670 vz	120,0	6 x 20,0 x 1,0	351 A	418 A	477 A	531 A	580 A	115,00
15671	15671 vz	160,0	8 x 20,0 x 1,0	413 A	492 A	562 A	625 A	683 A	153,30
15672	15672 vz	200,0	10 x 20,0 x 1,0	470 A	560 A	640 A	711 A	777 A	191,60
51731	51732*	240,0	11 x 20,0 x 1,0	497 A	592 A	676 A	752 A	821 A	229,90
15673	15673 vz	48,0	2 x 24,0 x 1,0	223 A	265 A	303 A	337 A	368 A	46,00
15674	15674 vz	72,0	3 x 24,0 x 1,0	276 A	329 A	375 A	417 A	456 A	69,00
15675	15675 vz	96,0	4 x 24,0 x 1,0	322 A	383 A	438 A	487 A	532 A	92,00
15676	15676 vz	120,0	5 x 24,0 x 1,0	363 A	433 A	494 A	550 A	600 A	115,00
15677	15677 vz	144,0	6 x 24,0 x 1,0	402 A	479 A	547 A	608 A	664 A	138,00
15678	15678 vz	192,0	8 x 24,0 x 1,0	471 A	562 A	641 A	713 A	779 A	183,90
15679	51735 *	240,0	10 x 24,0 x 1,0	534 A	637 A	727 A	809 A	883 A	229,90
15690	15690 vz	64,0	2 x 32,0 x 1,0	280 A	334 A	382 A	424 A	463 A	61,30
15691	15691 vz	96,0	3 x 32,0 x 1,0	346 A	413 A	471 A	524 A	572 A	92,00
15692	15692 vz	128,0	4 x 32,0 x 1,0	403 A	480 A	548 A	610 A	666 A	122,60
15693	15693 vz	160,0	5 x 32,0 x 1,0	453 A	540 A	617 A	686 A	749 A	153,30
15694	15694 vz	192,0	6 x 32,0 x 1,0	500 A	596 A	680 A	756 A	826 A	183,90
15695	15695 vz	256,0	8 x 32,0 x 1,0	583 A	695 A	793 A	882 A	963 A	245,30
15696	15696 vz	320,0	10 x 32,0 x 1,0	657 A	783 A	894 A	995 A	1086 A	306,60
15697	15697 vz	120,0	3 x 40,0 x 1,0	415 A	494 A	565 A	628 A	686 A	115,00
15698	15698 vz	160,0	4 x 40,0 x 1,0	481 A	574 A	655 A	729 A	796 A	153,30
15699	15699 vz	200,0	5 x 40,0 x 1,0	541 A	644 A	736 A	818 A	894 A	191,60
15700	15700 vz	240,0	6 x 40,0 x 1,0	594 A	708 A	809 A	900 A	982 A	229,90
15701	15701 vz	320,0	8 x 40,0 x 1,0	690 A	822 A	939 A	1044 A	1140 A	306,60
15702	15702 vz	400,0	10 x 40,0 x 1,0	774 A	922 A	1053 A	1171 A	1279 A	383,20
15703	15703 vz	200,0	4 x 50,0 x 1,0	577 A	688 A	786 A	874 A	954 A	191,60
15704	15704 vz	250,0	5 x 50,0 x 1,0	646 A	770 A	880 A	978 A	1068 A	239,50
15705	15705 vz	300,0	6 x 50,0 x 1,0	709 A	844 A	965 A	1073 A	1171 A	287,40
15706	15706 vz	400,0	8 x 50,0 x 1,0	818 A	975 A	1114 A	1238 A	1352 A	383,20
15707	15707 vz	500,0	10 x 50,0 x 1,0	914 A	1089 A	1244 A	1383 A	1510 A	479,00
15708	15708 vz	252,0	4 x 63,0 x 1,0	698 A	832 A	950 A	1056 A	1153 A	241,40
15709	15709 vz	315,0	5 x 63,0 x 1,0	779 A	929 A	1061 A	1179 A	1288 A	301,80
15710	15710 vz	378,0	6 x 63,0 x 1,0	852 A	1015 A	1159 A	1289 A	1408 A	362,10
15711	15711 vz	504,0	8 x 63,0 x 1,0	978 A	1166 A	1332 A	1481 A	1617 A	482,80
15712	15712 vz	630,0	10 x 63,0 x 1,0	1088 A	1296 A	1481 A	1646 A	1798 A	603,50
15713	15713 vz	400,0	5 x 80,0 x 1,0	947 A	1128 A	1289 A	1433 A	1565 A	383,20
15714	15714 vz	480,0	6 x 80,0 x 1,0	1032 A	1229 A	1404 A	1562 A	1705 A	459,80
15715	15715 vz	640,0	8 x 80,0 x 1,0	1179 A	1405 A	1604 A	1784 A	1948 A	613,10
15716	15716 vz	800,0	10 x 80,0 x 1,0	1305 A	1556 A	1777 A	1976 A	2157 A	766,40
15717	15717 vz	500,0	5 x 100,0 x 1,0	1136 A	1354 A	1546 A	1720 A	1878 A	479,00
15718	15718 vz	600,0	6 x 100,0 x 1,0	1235 A	1471 A	1681 A	1869 A	2041 A	574,80
15720	15720 vz	800,0	8 x 100,0 x 1,0	1404 A	1674 A	1912 A	2126 A	2321 A	766,40
15722	15722 vz	1000,0	10 x 100,0 x 1,0	1550 A	1848 A	2110 A	2347 A	2562 A	958,00

## Remark:

Stocked standard design bare and the \* marked tinned designs. In special design all dimensions are deliverable with a tin coated surface and in variable lengths (e.g. 3 m). All information about current load are approximate values in consideration of the heat for single laying of air cooled bars and ambient temperature + 35° C.

The temperature of the conductor is in dependent on the installation, the application, the cooling, the ambient temperature etc., so that if necessary reducing factors are to be considered. With pleasure our employees assist your company in finding optimal solutions.



## Finished machined supple bars/drawing components



As more and more switchgear and power transmission devices come onto the market in more compact designs, laminated supple bars offer an extremely inexpensive and space-saving way of making power connections within power transmission systems. Due to the different bending technologies available in our company, we can also produce extremely deformed, finished laminated supple bars bent, perforated, drilled according to customer requirements or drawings. We manufacture individual parts and smaller quantities as well as series parts with continuous deliveries at short notice. Here are a few examples of our diverse bending options.



## Bus- and supple bar connectors

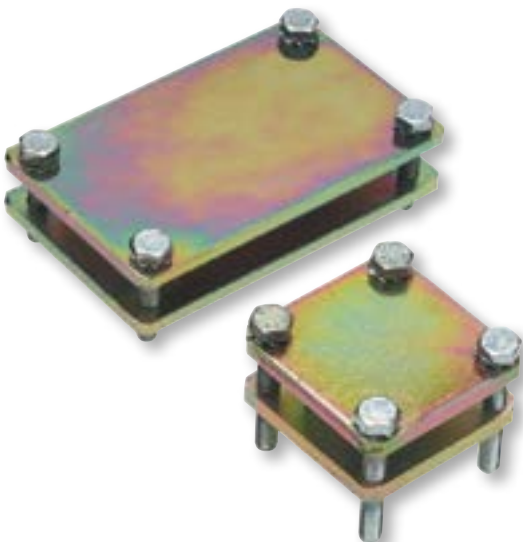

Part-No.	Technical data				
	dimensions mm				weight kg/pcs.
	compartment L x B	outer dimension L x B	screws	torque	
02220	18 x 18	35 x 39	M 6 x 25	6 Nm	11,00
02221	33 x 33	50 x 50	M 6 x 40	6 Nm	22,00
02222	35 x 51	57 x 75	M 6 x 30	6 Nm	29,00
02223	41 x 41	60 x 60	M 6 x 50	6 Nm	32,00
02224	42 x 64	63 x 63	M 6 x 30	6 Nm	36,00
02225	53 x 53	75 x 75	M 6 x 50	6 Nm	50,00
02226	42 x 82	63 x 103	M 6 x 30	6 Nm	45,00
02227	64 x 64	80 x 80	M 6 x 50	6 Nm	54,00
02228	82 x 82	120 x 120	M10 x 50	20 Nm	139,00
02229	102 x 102	140 x 140	M12 x 80	25 Nm	320,00

**Remark:**

Material zinc coated and chrome plated steel. Suitable to connect busbars between each other as well as busbars with our insulated supple bars. Busbar connectors with other dimensions as in our table are available on request.

## Hexagon head screws DIN 931/DIN 933

Material: stainless-steel A2



DIN 931



DIN 933

Bolt length mm	Part-No. of the screws						
	M5	M6	M8	M10	M12	M16	M20
30	53101	53140	-	-	-	-	-
35	53102	53141	53180	-	-	-	-
40	53103	53142	53181	53220	-	-	-
45	53104	53143	53182	53221	53260	-	-
50	53105	53144	53183	53222	53261	-	-
55	-	53145	53184	53223	53262	53301	-
60	-	53146	53185	53224	53263	53302	-
65	-	-	53186	53225	53264	53303	53341
70	-	-	53187	53226	53265	53304	53342
80	-	-	53188	53227	53266	53305	53343
90	-	-	53189	53228	53267	53306	53344
100	-	-	53190	53229	53268	53307	53345
110	-	-	-	-	53269	53308	53346
120	-	-	-	-	53270	53309	53347

**Remark:** When ordering, please indicate the desired DIN. If a version is desired in A4 stainless-steel, please indicate A4 in the order.

## Threaded Rods

Material: stainless-steel A2/A4 or brass



Part-No.			Technical data	
Material: A2	Material: A4	Material: brass	dimensions mm	
			Thread	Rod length
17980	18030	18080	M 3	1 m
17985	18035	18085	M 4	1 m
17990	18040	18090	M 5	1 m
17995	18045	18095	M 6	1 m
18000	18050	18100	M 8	1 m
18005	18055	18105	M10	1 m
18010	18060	18110	M12	1 m
18015	18065	18115	M16	1 m
18020	18070	18120	M20	1 m

## Clamping discs, DIN 6796

Material: spring steel

Surface: ZN 12 M + Passivation

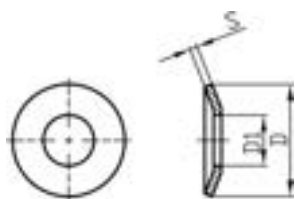

Part-No.	Technical data				
	dimensions mm				package unit/pcs.
	for bolt	D <sub>1</sub>	D	S	
18350	M 3	3,2	7	0,5	1000
18355	M 4	4,3	9	0,8	1000
18360	M 5	5,3	11	1,0	1000
18365	M 6	6,4	14	1,2	1000
18370	M 8	8,4	18	2,0	500
18375	M10	10,5	23	2,0	100
18380	M12	13,0	29	2,5	100
18390	M16	17,0	39	3,5	100
18395	M20	21,0	52	5,5	100

## Discs DIN 7349

Material: stainless-steel A2

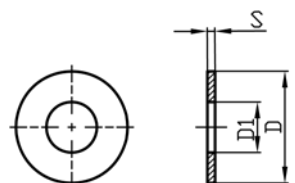

Part-No.	Technical data				
	dimensions mm				package unit/pcs.
	for bolt	D <sub>1</sub>	D	S	
18400	M 3	3,2	9	1,0	500
18402	M 4	4,2	12	1,6	500
18404	M 5	5,3	15	2,0	500
18406	M 6	6,4	17	3,0	500
18408	M 8	8,4	21	4,0	500
18410	M10	10,5	25	4,0	200
18412	M12	13,0	30	6,0	100
18414	M16	17,0	40	6,0	100
18416	M18	19,0	44	8,0	50
18418	M20	21,0	44	8,0	50

**Note:** If desired available in stainless-steel A4 too

### Hexagon nuts DIN 934

Material: stainless-steel A2

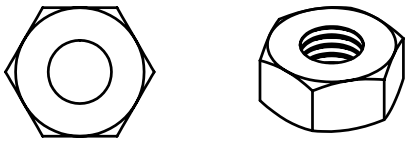

Part-No.	Technical data	
	thread	package unit/pcs.
18150	M 3	500
18155	M 4	500
18160	M 5	500
18165	M 6	100
18170	M 8	100
18175	M 10	100
18180	M 12	100
18185	M 16	100
18190	M 20	100

Note: If desired, also available in stainless-steel A4.

### Washers

Material: stainless-steel A2



DIN 125

DIN 9021

Part-No. DIN 125	Part-No. DIN 9021	Technical data			
		for bolt	outside-Ø		package unit/pcs.
			DIN 125	DIN 9021	
18200	18241	M 3	7,0	9	500
18205	18242	M 4	9,0	12	500
18210	18243	M 5	10,0	15	500
18215	18244	M 6	12,5	18	500
18220	18245	M 8	17,0	25	500
18225	18246	M 10	21,0	30	100
18230	18247	M 12	24,0	40	100
18235	18248	M 16	30,0	50	100
18240	18249	M 20	37,0	60	100

Note: If desired, also available in stainless-steel A4.

### Spring washers DIN 127 B

Material: stainless-steel A2

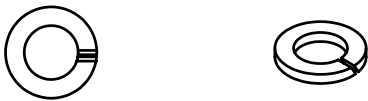

Part-No.	Technical data		
	for bolt	hole-Ø mm	package unit/pcs.
18250	M 3	3,1	500
18255	M 4	4,1	500
18260	M 5	5,1	500
18265	M 6	6,1	500
18270	M 8	8,2	100
18275	M10	10,2	100
18280	M12	12,2	100
18285	M16	16,2	100
18290	M20	20,2	50

Note: If desired, also available in stainless-steel A4.

### Serrated washers DIN 6798

Material: bronze



Part-No.	Technical data		
	for bolt	hole-Ø mm	package unit/pcs.
18300	M 3	3,2	500
18305	M 4	4,3	500
18310	M 5	5,3	500
18315	M 6	6,4	500
18320	M 8	8,4	500
18325	M10	10,5	100
18330	M12	12,5	100
18335	M16	18,5	100

Note: If desired, also available in stainless-steel A4.

### Insulating grommets

Material: epoxy glass hard resin

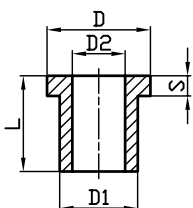

Part-No.	Technical data					
	for bolt	L	D	dimensions mm		
				D <sub>1</sub>	D <sub>2</sub>	S
53450	M 8	32	20	14	9	4
53455	M10	32	23	16	11	4
53460	M12	34	25	18	13	6
53465	M16	32	32	22	17	6
53470	M20	38	38	27	21	8

Note: These insulating grommets are used for insulating fastening bolts from the tank or other metal parts, e.g. for contact block fastening. The material epoxy glass hart resin is well suited in terms of temperature resistance as well as its resistance to pressure as, e.g. in the use of electroplating plants.

## Technical appendix

### Selecting an safety instructions by using our current transmission elements

#### General advice

The measurements and technical information written in this catalogue have been determined with greatest care and updated continuously in our documentation. We reserve us the right to make technical as well as changes of measurements, colours or formats after print. Our information especially the values for possible current loads are not binding, they are only approximate values under optimized conditions. The relation between conductor cross-section and current load fixed in national or international regulations are not cancelled through our information. Also it is necessary to pay attention to the following facts. Only the values in our written order confirmations are binding for us.

#### Demands to current transfer elements

All components for current transfer must be selected under the condition that by using the components in accordance with the regulations or requirements no unacceptable risk are created for life and health of persons as well as a damaging of objects. To guarantee these demands it is absolutely necessary to check and analyze possible risks, source of errors and rest risks even when planning or designing plants or products. All components for current transfer must be so calculated that they are sufficient dimensioned for all possible load (current as well as voltage) which can be occurred inside of the planed application. Particularly by existing limit conditions it is necessary to take the values of the current rates or voltages fixed in national or international regulations into consideration.

#### Values of influence

Following some short examinations of the fundamental facts, which have an influence of the construction of current transfer components. Please notice that it is important to consider and observe all facts together and not separately.

#### Selecting information

The fundamental facts for selecting the right current transfer components are the operating conditions and the outer influences. Operating conditions are the height of voltage and current, kinds of laying, the number of cables, the cooling possibilities, the safety devices etc. Outer influences are the ambient temperature, the existence of corrosive or other chemical substances, mechanical stress or special requirements concerning of the installation situation, the existence and influence of steam, moisture or radiation (e.g. sunlight). All these facts must be taken into account when constructing or designing solutions for current transfer applications.

#### Voltage

It is necessary to protect and insulate the flexible cables and current transfer components in coordination with the existing voltage of the application. The operation voltage of cables is defined in Volt by the values  $U_0/U$ . It is the voltage which determines the construction and the electrical test procedures of the cables. Here is

$U_0$  = Value of the permissible voltage between an external conductor and earth  
 $U$  = Value of the permissible voltage between two external conductors of multicore or a system of single core cables.

According to the regulations of the VDE 0298 part 3 the operating voltage of the cables must be identical with the operating voltage of the whole system, when working with AC-voltage. This regulation is binding for the value  $U_0$  as well as for the value  $U$ . When working in a system with DC-voltage it is acc. to the VDE allowed to calculate with a maximum value of one and a half of the operating voltage of the cables. But we recommend to exceed the value not more than 10 % continuously.

#### Current load

The cross-section of a conductor should be so selected that its allowed current-load and the permissible maximum continuous load of the application should be identical or greater. Additionally you have to take the permissible heat resistance of the used insulation material and the possible voltage drops into your account. Some fundamental facts which have influence of the dimensioning of electrical conductors are therefore:

- Kind of laying and number of the conductors
- Voltage drop and electrical losses
- Ambient temperature
- Insulation material and thermal stress
- Cooling possibilities
- Frequency of the current (when > 50 Hz)
- Consequences of electrical waves etc.

Such influences must be compensated by the consideration of necessary reducing factors. Additionally all thermal influences must be taken into account, so that it is not possible to hinder a thermal radiation and a danger of fire is excluded.

#### Mechanical stress

Also it is necessary to calculate the risk of a possible mechanical stress. Fundamental values can be created by a tensile-, pressure-, torsion- and bending stress or other facts created by the handling, transport or installation. Electrical elements which are particularly subjects of mechanical stress or flexible components which have to realize movements must be selected very carefully and well suited to the application. With pleasure our employees assist your efforts in finding optimized solutions.

#### Coordination of components to the different applications

When selecting flexible cables or components it is necessary to pay attention to the application, the installation, the ambient conditions and to all risks arising out of these facts. So a consideration of the following facts is important too:

- Avoidance of a possible mechanical or electrical influence between bordered power systems
- Thermal radiation as well as chemical or physical influences of the conductor, the insulation or other bordered materials
- Examination of possible influences or reactions between bordered materials and the conductor with his insulation
- Examination of the fixing and the fixing materials concerning possible damages e.g. caused by the dynamic strength in case of short circuit situations.

#### Service and maintenance

Electrical equipment requires continuous control, maintenance and servicing. The intervals and activities to be carried out depend on the individual conditions of use and the applicable legal regulations. Pay particular attention to soiling and damaged components. For the execution of screw connections, we recommend that the guidelines for DIN 43673 part 1 busbars, busbar drill holes and – screw connections be taken into account. When screwing copper to aluminium components, bimetallic material should be used as an intermediate layer (see also our information on catalogue pages 14 + 15). We will be happy to send you detailed screw connection recommendations for flexible or high current connectors and busbars on request or advise you on your applications.



## Technical appendix

### short circuit-values/support-distances

#### Busbar supports, Part-No. 15645

phasing-distance 100 mm, fixed with 4 screws M12

E-copper-bars		max. support-distance mm												
number and dimensions	rated current	lcw up to	10 kA	15 kA	20 kA	25 kA	30 kA	40 kA	50 kA	60 kA	65 kA	70 kA	80 kA	
		lpk up to	21 kA	32 kA	42 kA	53 kA	63 kA	84 kA	105 kA	132 kA	143 kA	154 kA	176 kA	
1 x 20 x 5	320 A		610	390	300	230	200							
2 x 20 x 5	590 A		860	560	420	330	280	210						
3 x 20 x 5	810 A		1060	690	520	410	340	260	200					
1 x 30 x 5	445 A		750	480	370	290	240							
2 x 30 x 5	790 A		1060	690	520	410	340	260	200					
3 x 30 x 5	1050 A		1200	840	640	500	420	310	250	200				
1 x 40 x 5	565 A		860	560	420	330	280	210						
2 x 40 x 5	980 A		1200	790	600	470	400	300	240					
3 x 40 x 5	1280 A		1200	970	740	580	490	360	290	230	215	200		
1 x 50 x 5	685 A		980	630	470	370	310	230						
2 x 50 x 5	1170 A		1200	890	670	530	450	330	260	210				
3 x 50 x 5	1475 A		1200	1090	830	650	550	410	320	260	240	220		
1 x 20 x 10	500 A		1200	790	600	470	400	300	240					
2 x 20 x 10	965 A		1200	1130	850	670	560	420	340	270	250	230	200	
1 x 30 x 10	670 A		1200	970	740	580	490	360	290	230	210	200		
2 x 30 x 10	1240 A		1200	1200	1050	830	690	520	400	330	300	280	220	
1 x 40 x 10	840 A		1200	1130	850	670	560	420	340	270	250	230	200	
2 x 40 x 10	1510 A		1200	1200	1200	950	800	600	480	380	340	290	220	
1 x 50 x 10	1000 A		1200	1200	950	750	630	470	380	300	270	250	220	
2 x 50 x 10	1770 A		1200	1200	1200	1200	900	670	530	400	340	290	220	
1 x 60 x 10	1155 A		1200	1200	1050	830	690	520	400	330	300	280	220	
2 x 60 x 10	2015 A		1200	1200	1200	1200	980	730	580	400	340	290	220	
1 x 80 x 10	1450 A		1200	1200	1200	950	800	600	480	380	340	290	220	
2 x 80 x 10	2470 A		1200	1200	1200	1200	1130	850	630	400	340	290	220	
1 x 100 x 10	1745 A		1200	1200	1200	1200	900	670	530	400	340	290	220	
2 x 100 x 10	2900 A		1200	1200	1200	1200	1200	980	630	400	340	290	220	
1 x 120 x 10	2035 A		1200	1200	1200	1200	980	730	580	400	340	290	220	
2 x 120 x 10	3350 A		1200	1200	1200	1200	1200	980	630	400	340	290	220	
1 x 160 x 10	2700 A		1200	1200	1200	1200	1130	850	630	400	340	290	220	
2 x 160 x 10	4350 A		1200	1200	1200	1200	1200	980	630	400	340	290	220	

#### Busbar supports, Part-No. 15646

phasing-distance 125 mm, fixed with 4 screws M12

E-copper-bars		max. support-distance mm												
number and dimensions	rated current	lcw up to	15 kA	20 kA	25 kA	30 kA	40 kA	50 kA	60 kA	65 kA	70 kA	80 kA	100 kA	
		lpk up to	32 kA	42 kA	53 kA	63 kA	84 kA	105 kA	132 kA	143 kA	154 kA	176 kA	220 kA	
1 x 40 x 10	840 A		1200	940	750	630	470	380	300	270	260	220		
2 x 40 x 10	1510 A		1200	1200	1070	900	670	530	420	390	360	320	250	
3 x 40 x 10	2070 A		1200	1200	1200	1100	820	650	520	480	440	390	270	
1 x 50 x 10	1060 A		1200	1070	840	710	530	420	330	310	280	250	200	
2 x 50 x 10	1770 A		1200	1200	1190	1000	750	600	470	440	400	350	270	
3 x 50 x 10	2390 A		1200	1200	1200	1200	920	730	580	540	500	430	270	
1 x 60 x 10	1155 A		1200	1170	920	770	580	460	370	340	310	270	220	
2 x 60 x 10	2015 A		1200	1200	1200	1100	820	650	520	480	440	390	270	
3 x 60 x 10	2690 A		1200	1200	1200	1200	1010	800	640	590	540	430	270	
1 x 80 x 10	1450 A		1200	1200	1070	900	670	530	420	390	360	320	250	
2 x 80 x 10	2470 A		1200	1200	1200	1200	950	760	600	550	510	430	270	
3 x 80 x 10	3265 A		1200	1200	1200	1200	1160	930	740	650	560	430	270	
1 x 100 x 10	1745 A		1200	1200	1190	1000	750	600	470	440	400	350	270	
2 x 100 x 10	2900 A		1200	1200	1200	1200	1060	850	670	620	560	430	270	
3 x 100 x 10	3815 A		1200	1200	1200	1200	1200	1040	760	650	560	430	270	
1 x 120 x 10	2035 A		1200	1200	1200	1100	820	650	520	480	440	390	270	
2 x 120 x 10	1200 A		1200	1200	1200	1200	1160	930	740	650	560	430	270	
3 x 120 x 10	4375 A		1200	1200	1200	1200	1200	1140	760	650	560	430	270	
1 x 160 x 10	2700 A		1200	1200	1200	1200	950	760	600	550	510	430	270	
2 x 160 x 10	4350 A		1200	1200	1200	1200	1200	1070	760	650	560	430	270	
3 x 160 x 10	5500 A		1200	1200	1200	1200	1200	1200	760	650	560	430	270	

Values in acc. with DIN 43671 by + 35° C air- and + 75° C busbar temperature.

Data refer to the use of copper (Rp 0,2) with a strength of 300 N/mm<sup>2</sup>.

lcw = Rated short-time withstand current.

lpk = Rated impulse withstand current.



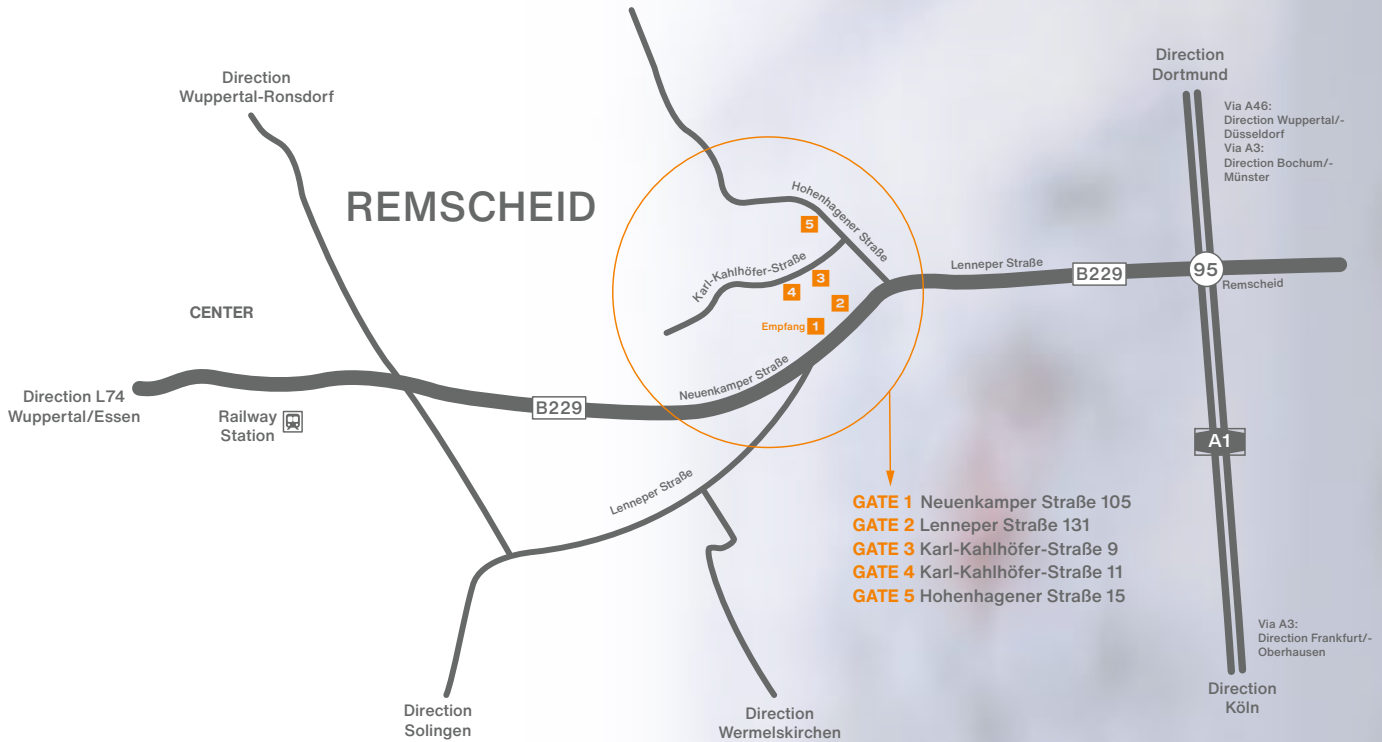

## Paul Druseidt

### Elektrotechnische Spezialfabrik GmbH & Co. KG

Neuenkamper Straße 105  
42855 Remscheid - Germany

Phone: +49 (21 91) 93 52-0  
Fax: +49 (21 91) 93 52-150  
Web: [www.druseidt.de](http://www.druseidt.de)  
E-Mail: [info@druseidt.de](mailto:info@druseidt.de)

Monday - Thursday:  
7:30 a.m. - 4:00 p.m.  
Friday:  
7:30 a.m. - 12:00 p.m.



Visit our online shop and use the convenient product search as well as the convenient inquiry and ordering process..  
Simply scan the QR code or enter it in your browser: [shop.druseidt.de](http://shop.druseidt.de)

### Use our download area or order our special catalogues to the following subjects:

**Catalogue 1:** Professional installation- and electrical connection technique for craft, industry and high current application

**Catalogue 2:** Highly flexible air- and water-cooled connectors and cables for hi-tech-applications in industrial and high current equipment

**Catalogue 3:** Contact systems and accessories for anodizing and electroplating plants

**Catalogue 4:** Busbars, non-ferrous metal working and accessories



DOWNLOAD